



AXON

TASER Training

TASER® X26P™ User Course

Conducted Electrical Weapons (CEWs)

Version 20.2 - Effective January 15, 2018

Goal

To provide the basic operational theory and practical training to reasonably, safely and effectively operate TASER Conducted Electrical Weapons (CEWs).

Course Objectives

Upon completion of this course, students will be able to:

- Explain the technology associated with X26P
- Describe the nomenclature and operation of the X26P
- Describe the nomenclature and operation of the TASER cartridge
- Explain proper care and troubleshooting techniques
- Explain CEW Smart Use Considerations
- Explain the Tactical Considerations associated with CEW use
- Explain proper probe placement and aiming requirements
- Demonstrate safe handling of CEWs

Training Version 20.2

With the release of Version 20.2, all prior TASER training materials and Training Bulletins are superseded and rendered obsolete.

Release and Warning Requirements

- **Warning Acknowledgement:** All students attending TASER User certification courses will be required to **acknowledge** that they have read and understand the warnings prior to participating in any hands-on CEW drills required by the certification course.
- **You are only required to sign a release if you take a voluntary exposure***
- Updated copies of Version 20.2 documents can be found on the Training Resource page at <https://www.axon.com/training/resources>

Disclaimers

- TASER Training does NOT set use of force policies, general orders, or procedures.
- TASER Training does not give legal advice and nothing contained in these training materials creates any form of attorney-client relationship. Be sure to consult with your local legal advisors for any legal advice, guidance, or direction.
- TASER training materials may include videos or other information from outside sources to facilitate discussion. The inclusion of such materials is not an endorsement of the procedures or tactics depicted.

Disclaimers

- Each agency is responsible for creating its own use of force policies and procedures.
- Use of force policy should address CEW use, and should be communicated to all officers.
- TASER CEWs are serious weapons and should be treated as such at all times.
- TASER CEWs are not a substitute for authorized deadly force.

Expectations

You must successfully complete the entire curriculum to be certified by TASER Training as a TASER user

- **Users must be recertified annually or more frequently as necessary to stay current with updated manufacturer warnings/training and court decisions**

Ask questions. If we do not know the answer, we will find it for you.

Safety Rules

- No live firearms in training area
- Every participant is responsible for immediately reporting any safety issues. If an unsafe condition occurs or is noticed during an exercise, the student or instructor observing the unsafe condition will call “**STOP ACTION!**”
- One student or instructor will be designated as the safety officer during each exposure, live fire and practical exercise/scenario*
- All activity will stop when any student or instructor calls “**STOP ACTION!**”

Safety Rules

- The safety switch on all TASER CEWs will remain in the down (SAFE) position unless the instructor directs students to arm the CEW or when it is appropriate to do so during a training drill
- TASER CEWs must not be pointed at any person or body part unless the instructor directs students to do so as part of a training exercise or scenario

Safety Rules

- A TASER CEW loaded with a live cartridge must not be pointed at another person or body part except during voluntary exposures
- An LS (blue) training cartridge must be used for simulation exercises when the subject being targeted is wearing a protective simulation suit
- LASERs must not be pointed at eyes
- Probes must be removed according to proper protocol

TASER CEWs Are Not Risk Free

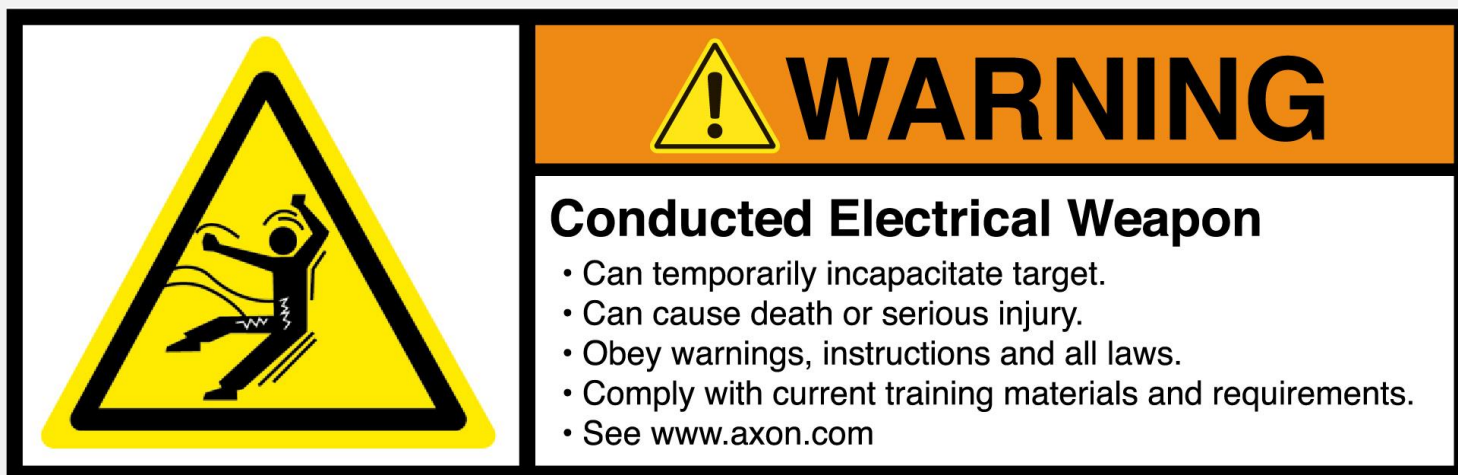

Review and understand TASER current product warnings



Brief Overview of CEW Technology

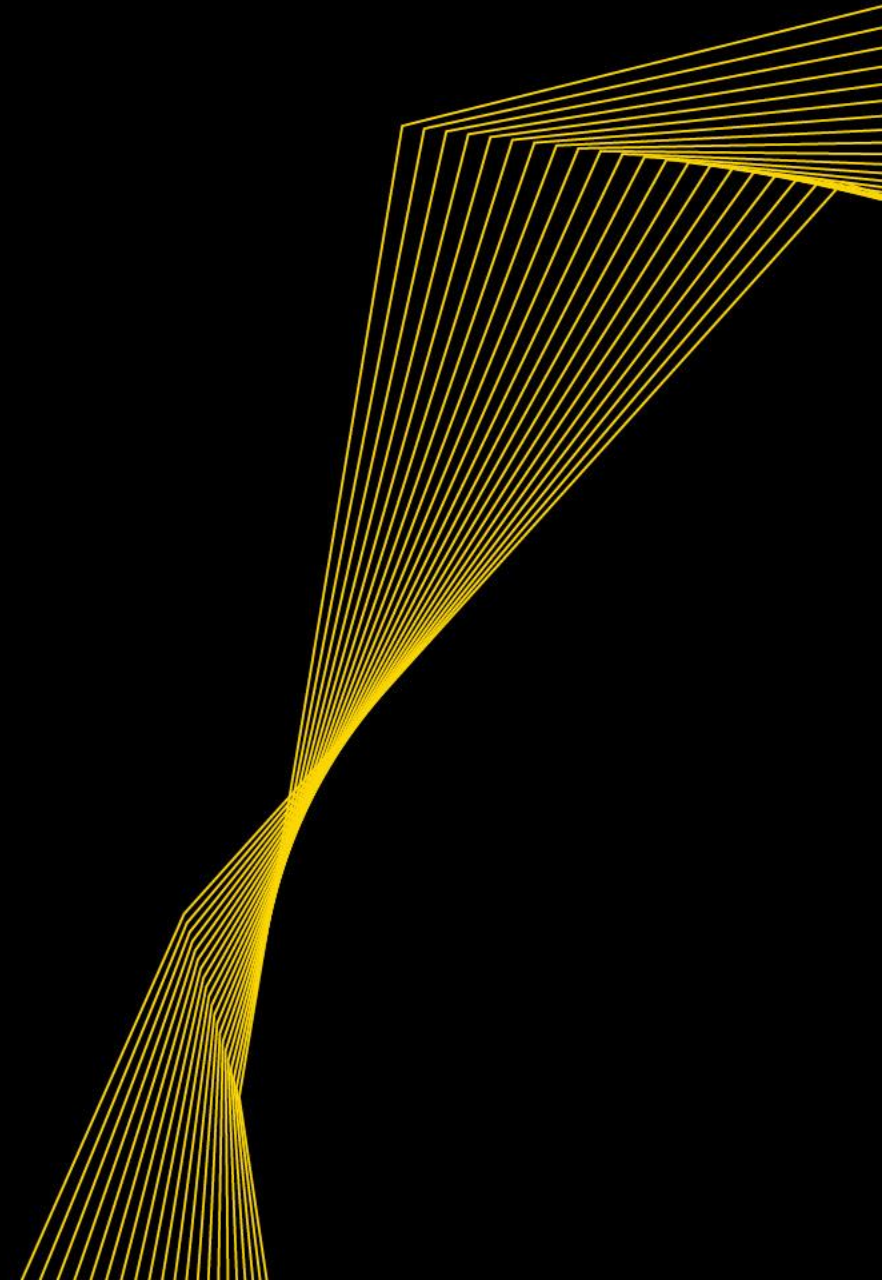

TASER: Low Average Current

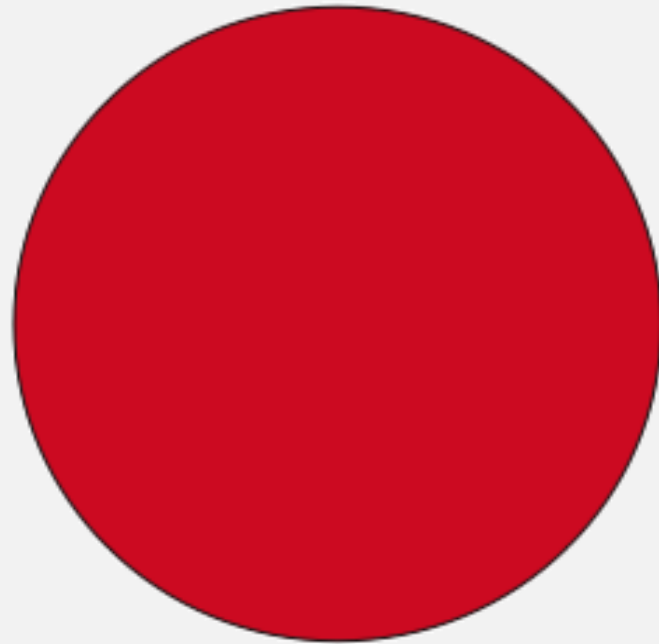

**100 V Wall
Outlet
16.0 A**



**Christmas
Tree Bulb
1.0 A**



**TASER Output
X26P
0.0012**



**HIGH VOLTAGE –
Greater than 1,000,000 volts**

Arcing Probes

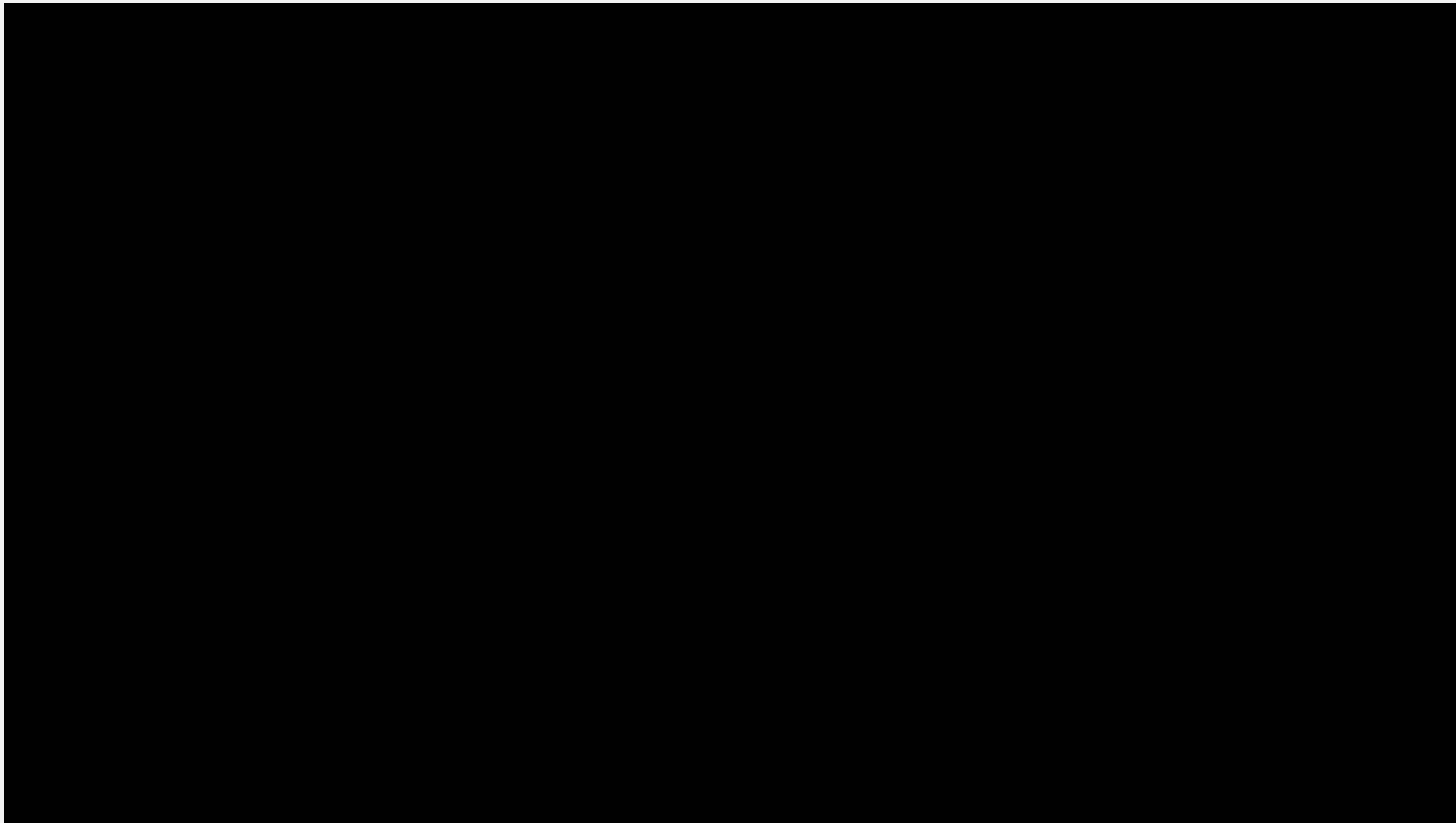

Neuro-Muscular Incapacitation

- There are different levels of Neuro-Muscular Incapacitation (NMI) ranging from limited area effects to significant body lockup
- The greater the probe spread, the higher likelihood of NMI
- CEWs may not achieve total NMI
- Subject may maintain muscle control, particularly in arms and legs, depending on many factors including probe locations
- Be prepared with other force options, including a drive-stun follow up to expand NMI in close probe spread situations
- Drive stuns alone cause only localized pain, not NMI

Nervous System Stun vs. NMI

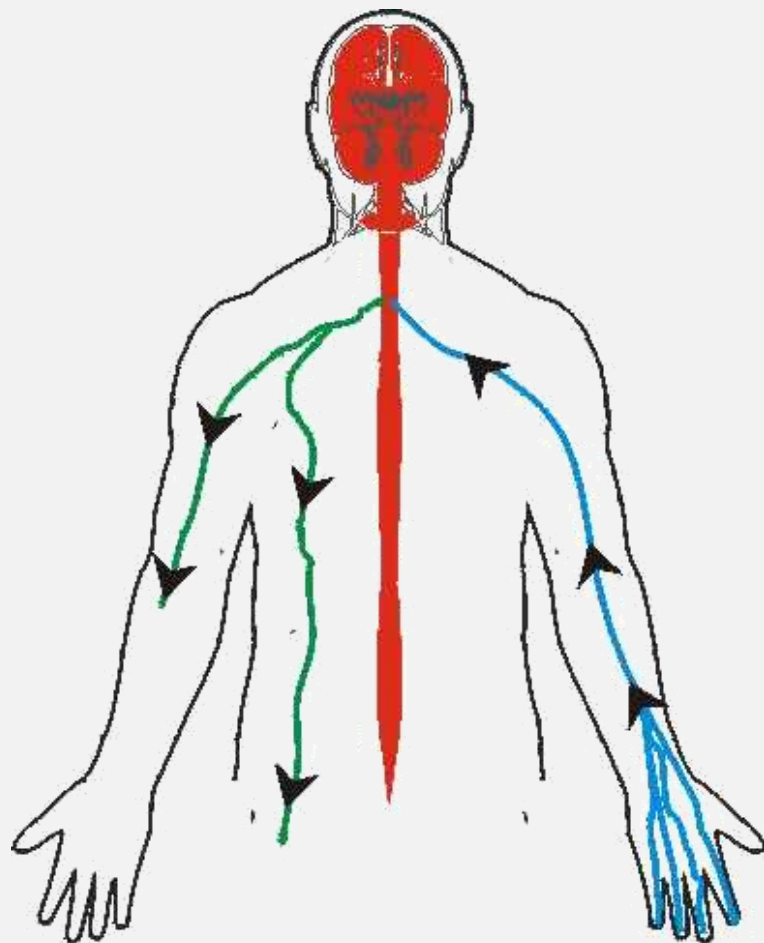

Central Nervous System

Command center – brain & spinal cord.

Motor Nervous System

Carries commands from the brain to muscles (NMI systems affect BOTH the sensory and motor nerves)

Sensory Nervous System

Brings information into the brain (effected by stun systems)



Voluntary Exposures



Voluntary Exposure

- TASER Training does **NOT** require a CEW exposure for user certification
- Voluntary CEW exposure is each agency's sole and exclusive decision
- Voluntary CEW exposures must only be conducted by a currently certified TASER Instructor adhering to TASER training
- Group CEW exposures are prohibited

Voluntary Exposure

- CEW probe exposures involve strong muscle contractions and physical exertion similar to strenuous athletic activities. Risks of injury from stress, physical exertion, falling, etc. while low, are not zero (see full warnings)
- Notify instructor verbally and in writing on RELEASE form of any pre-existing injuries, medical conditions, or individual susceptibilities
- All volunteers must review the current TASER warnings and complete the RELEASE prior to any exposure

Voluntary Exposure

| Benefits | Risks |
|--|--|
| <ul style="list-style-type: none">▪ Officers can better understand the effects of the CEW<ul style="list-style-type: none">– For deployment– Confidence to go “hands-on” without receiving shock– Self-defense– Court expertise– Secondary exposures | <ul style="list-style-type: none">▪ Stress, anxiety, panic▪ Exertion and effects▪ Strong muscle contractions and effects▪ Discomfort or painful experience▪ Significant injuries have occurred <p>(SEE FULL WARNINGS)</p> |

Voluntary Exposure Guidelines

- Eye protection is required for the spotters, volunteer, and anyone within the training area if probes are fired in lieu of attaching spent wires or alligator clips
- Probes should be deployed from behind the volunteer (avoids face, throat, genitals, breasts, chest or area of the heart)
- Properly supported by two spotters to prevent falls, or placed face down on the mat prior to exposure
- Realistic field probe placements only

Voluntary Exposure Guidelines

Each spotter should hold an upper arm of the standing volunteer under the armpit, so that:

- The shoulder, arm, elbow, and wrist are stabilized close to the body to prevent stress/tension on the joints
- The volunteer can be safely supported and lowered to the ground after being hit without twisting, rotating, or putting undue stress on the arm or shoulder; or flailing/jerking forward after discharge

Voluntary Exposure Requirements

- Proper matting
- Clear area of bystanders and objects
- Make area safe
- Careful probe removal using proper protocols

Subjects with pre-existing injuries, medical conditions, or individual susceptibilities should avoid CEW exposure or areas of concern

**WARNING: FAILURE TO FOLLOW SAFETY PROCEDURES
INCREASES THE RISK OF INJURY**

Voluntary Exposure WARM-UP

Prior to receiving a CEW exposure, volunteers SHALL stretch and warm-up as before exercising or athletics.

- Back
- Shoulders
- Arms
- Legs
- Torso

Back Exposure



Single Probe Hit – Drive-Stun Follow Up



Probe Removal and Evidence Considerations





TASER X26P



TASER X26P

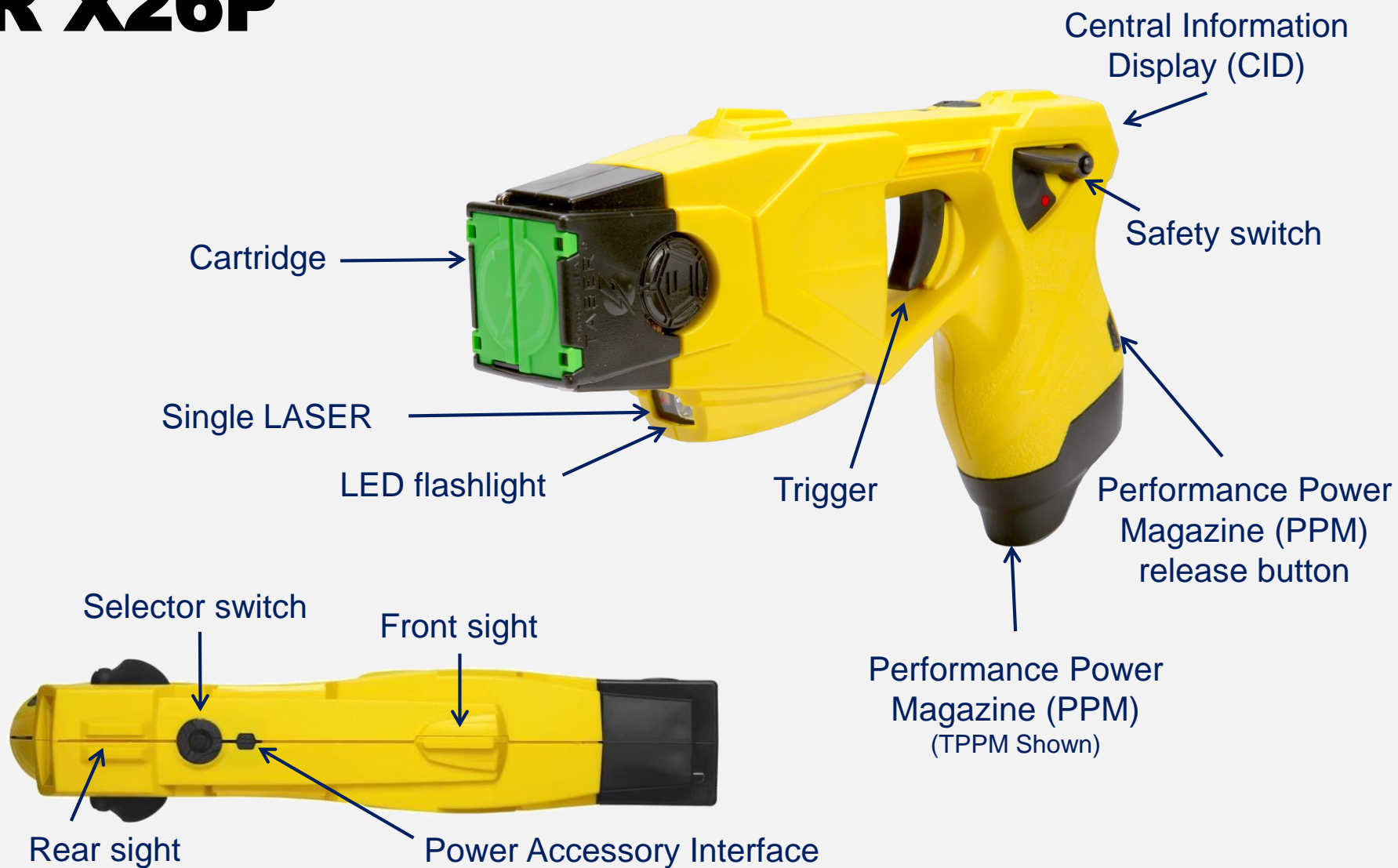

Safety Switch

- Safety Switch Down
 - (SAFE)
- Safety Switch Up
 - (ARMED)
 - Activates CID, LASERS and illumination
 - Begins events in the Event log



Safety Switch

- The ambidextrous safety switches do not operate independently of each other
- Do not block the safety switch on the side of the X26P while attempting to move it on the other side
 - Blocking the safety switch can cause it to break and disable the X26P
- The safety switch does not need to move very far to arm the X26P
- It is highly recommended that the X26P be kept in a holster that engages the safety switch when not in use

CID - Power Source Status Icons

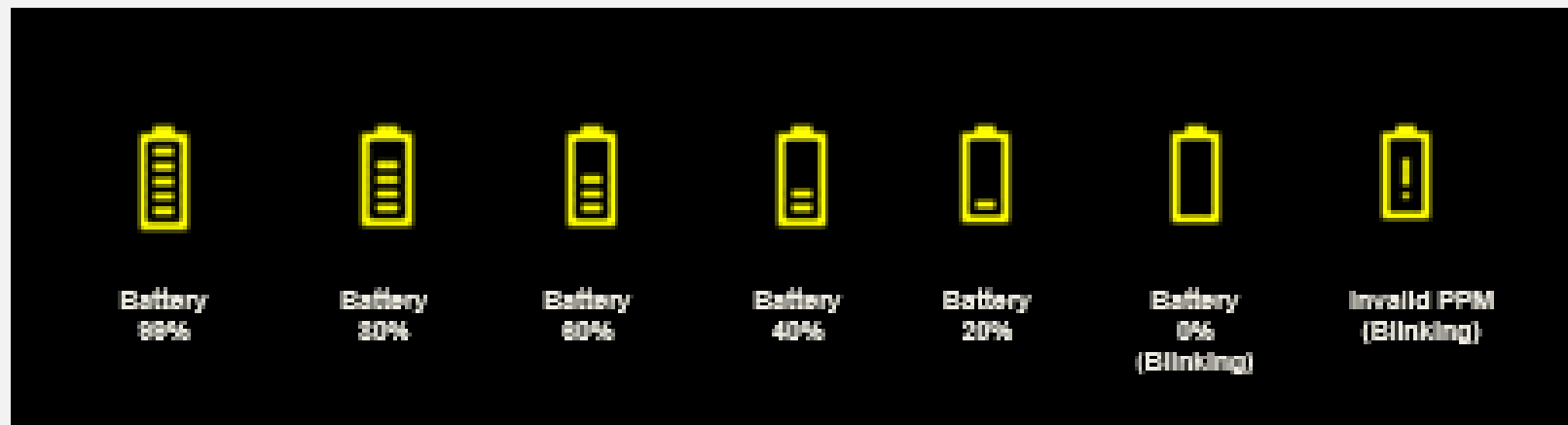
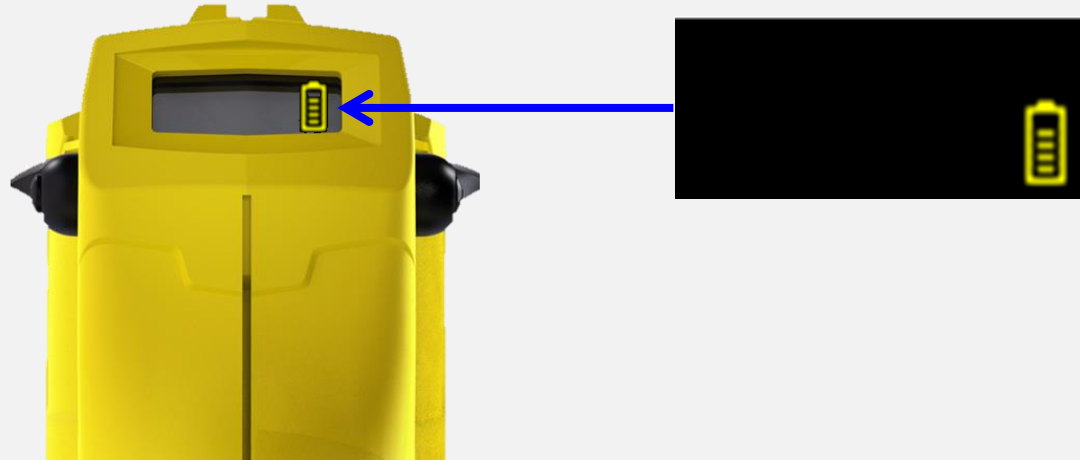

Trigger Operation

- Single trigger pull and release discharges an electrical charge for a 5-second cycle
- Shift the safety switch down (SAFE) to stop a discharge at any time (e.g., if accidentally discharged)
- Holding the trigger continuously beyond the 5-second cycle will continue the electrical discharge until the trigger is released unless an APPM or XAPPM is used.

Re-Energizing Cartridge

- Once a cartridge is fired, the operator can re-energize the cartridge by pulling the trigger
- Each trigger pull when the X26P is not cycling will initiate another 5-second cycle
 - Additional trigger pulls during the 5-second cycle will not extend the cycle unless the trigger is held back

Know Your CEW Trigger Operation

Continuous Discharge

- Remember if you hold the trigger back the X26P will continue to discharge after the 5-second cycle until you release the trigger as long as there is sufficient battery charge (does not apply to X26P with APPM)
- Holding the trigger back may result in repeated or continuous CEW discharges, allegations of excessive force, and increased potential for subject injury

Display Count Up

- Display will count up for single trigger pull (e.g., 1,2,3,4,5)
- Will continue to count up (e.g., 6,7,8...) if the trigger is held past the 5-second cycle

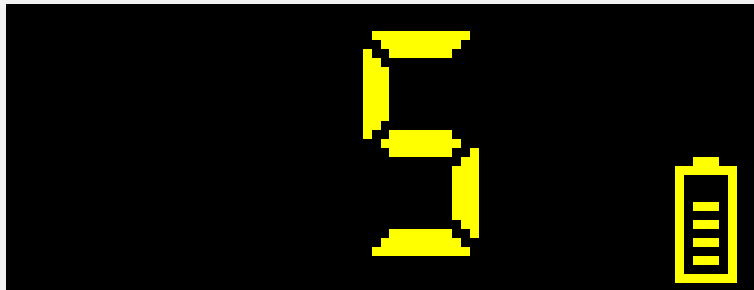

Selector Switch

- Used to select the sighting options of the X26P and place the unit into stealth mode
- Use only your finger to depress the selector switch

Do not use objects like pens, paper clips or knives as this can cause the switch to break or stick

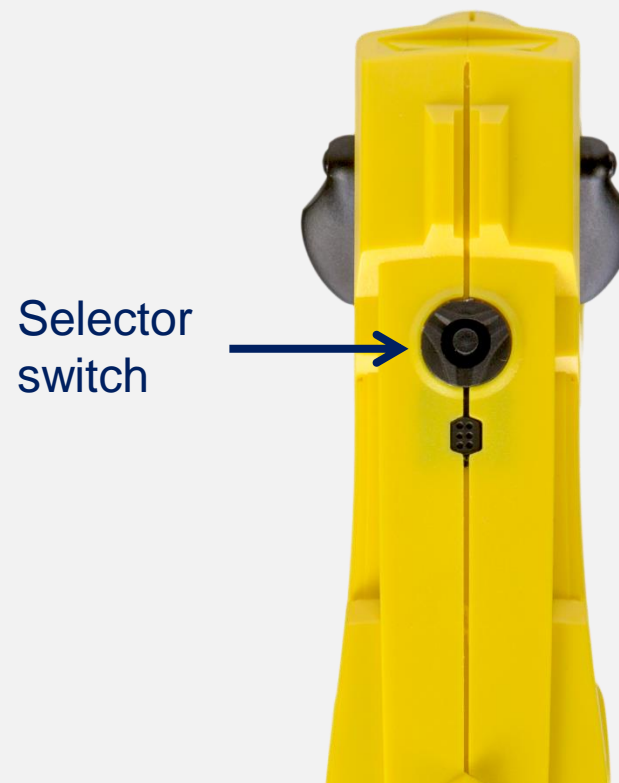

LASER and Light Settings

- OO - Stealth, no LASER, no flashlight, CID dims
- LO - LASER only
- OF - Only flashlight
- LF - LASER and flashlight



Performance Power Magazine (PPM)

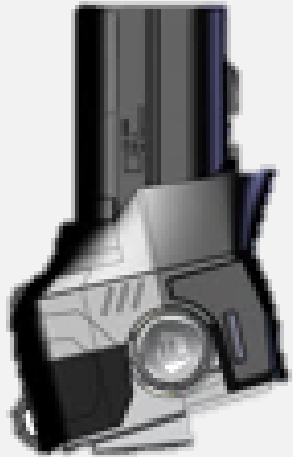

XPPM



TPPM



PPM



APPM



TASER CAM HD

Axon Signal SPPM Demonstration

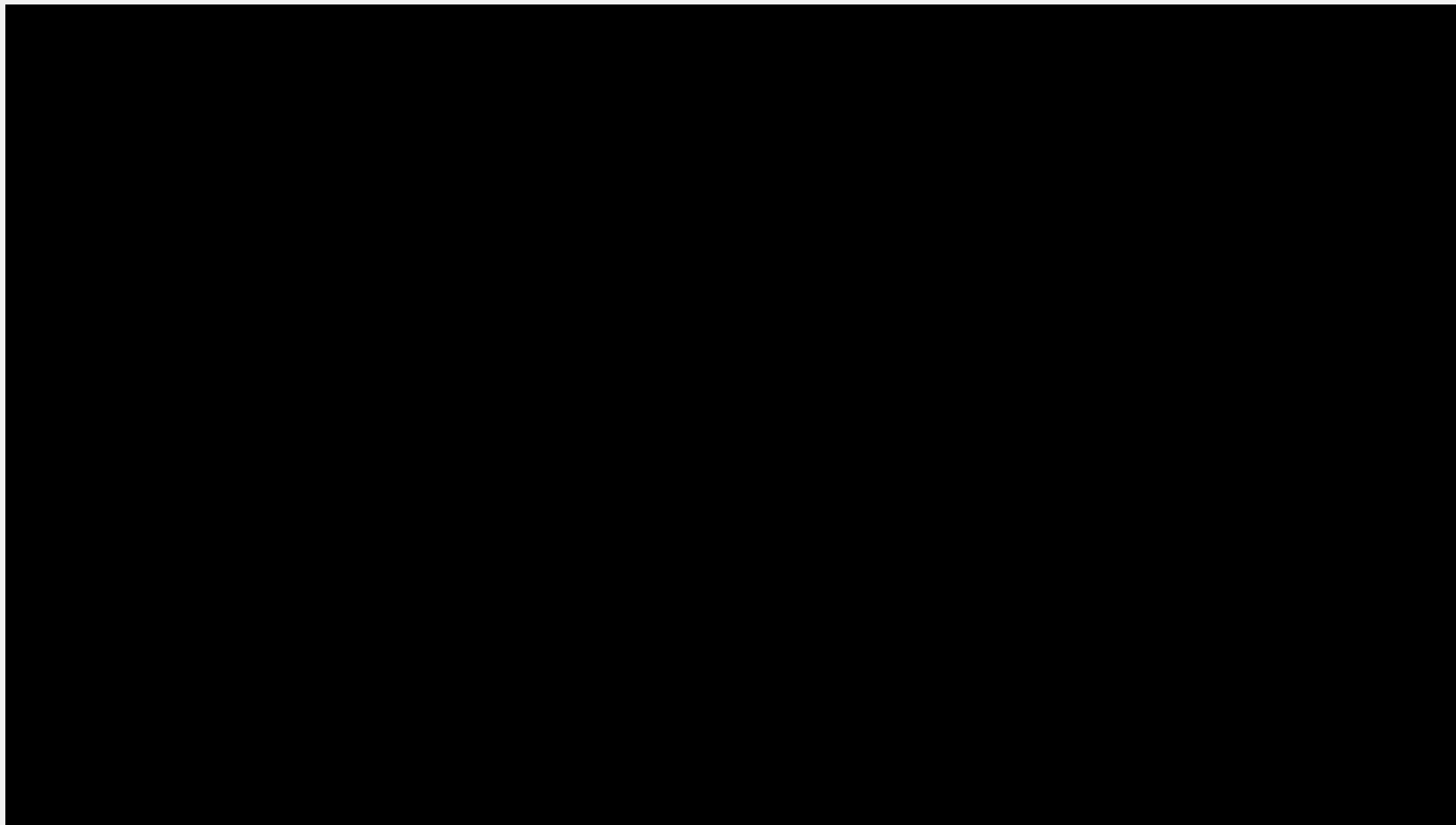

PPM Replacement

1. Press the PPM release button
2. Pull down on PPM
3. Depress and hold the PPM release button
4. Insert the new PPM until it is fully seated and release the PPM release button



Spark/Functionality Test

- **A full 5-second Spark/Functionality test** should be conducted once every 24 hours or prior to the start of your shift for individually issued X26P to:
 - Check that the X26P is sparking
 - Check the battery performance
 - Check CID to ensure there are no fault icons
- Be aware of potential stress memory concerns of deactivating CEW in field use too quickly
- Follow agency protocol and Spark/Functionality Tests safety guidelines



TASER Cartridge



Cartridges

- TASER cartridges are used in the M26, X26, and X26P CEWs
 - Available in 15, 21, and 25 foot



- TASER cartridges are deployed by a CEW electrical discharge
 - Discharging CEW, static electricity, or other electrical source can cause inadvertent cartridge deployment.
 - Keep hands away from the front of cartridges
 - Do not inadvertently point cartridges at yourself or anyone else

Cartridge Safety



Cartridges



15 ft.
(4.6 meters)
Yellow blast doors
Live cartridge
Regular probe



21 ft.
(6.4 meters)
Silver blast doors
Live cartridge
Regular probe



XP 25 ft.
(7.6 meters)
Green blast doors
Live cartridge
XP probe



LS 21 ft.
(6.4 meters)
Blue cartridge/blue
blast doors
Short probe

TASER Cartridge

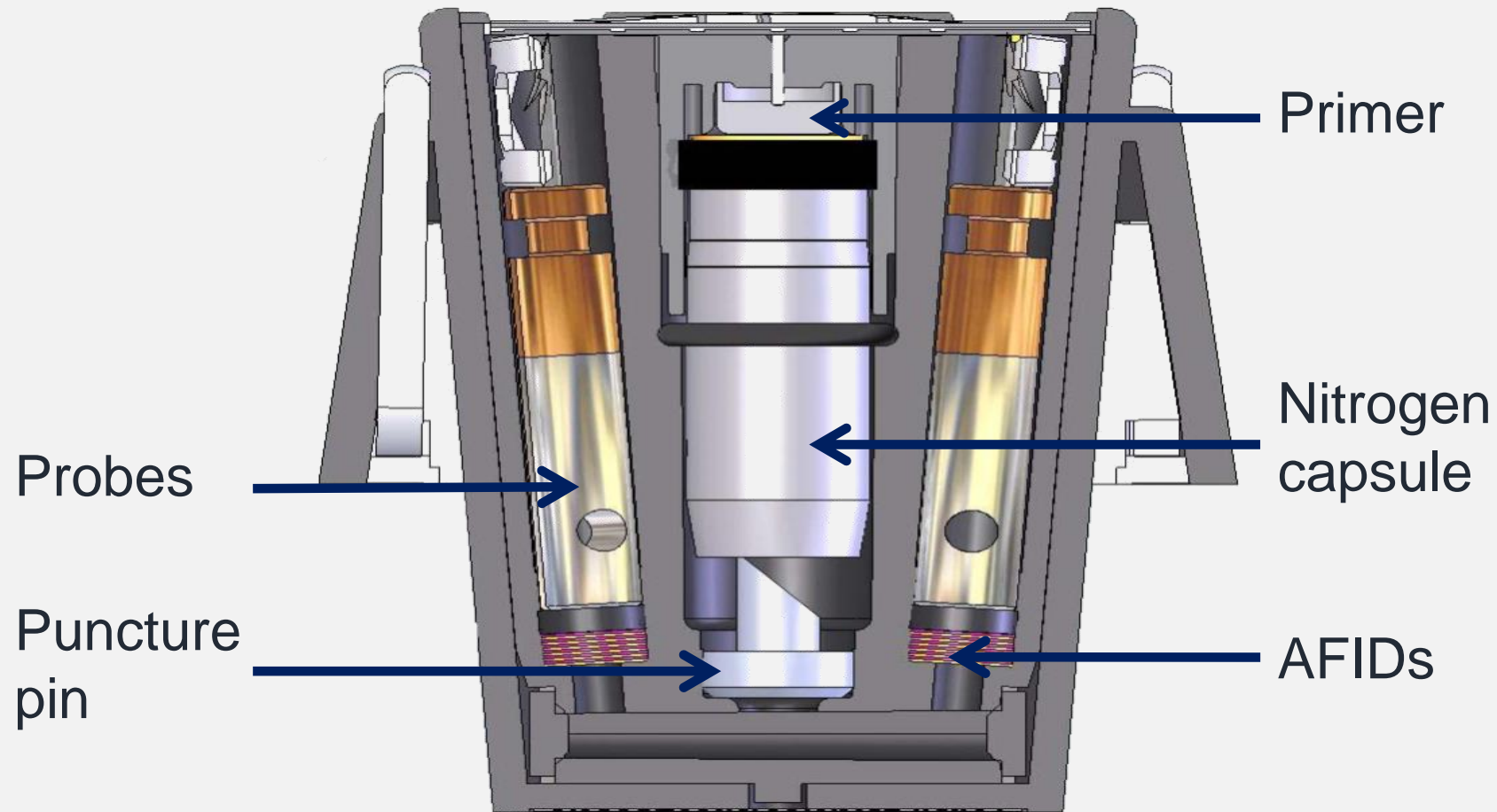

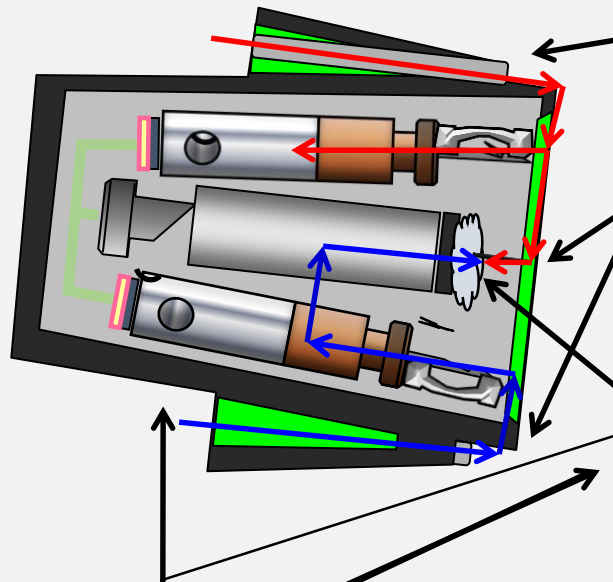

Electricity is conducted down the metal contacts and energizes ignition pin.

The electricity fires a small primer that forces the nitrogen capsule rearward into a hollow puncture pin that releases the compressed nitrogen into the probe chambers, which forces the probes out of the bores.

The blast doors, probes, probe wires, foam poron pads, ejectors and AFIDs are then propelled forward.

TASER Cartridge Probe Spread For 15, 21 & 25 Foot Cartridges

Rule of thumb: ~1 foot (.3 m) spread for every 7 feet (2.1 m) of travel

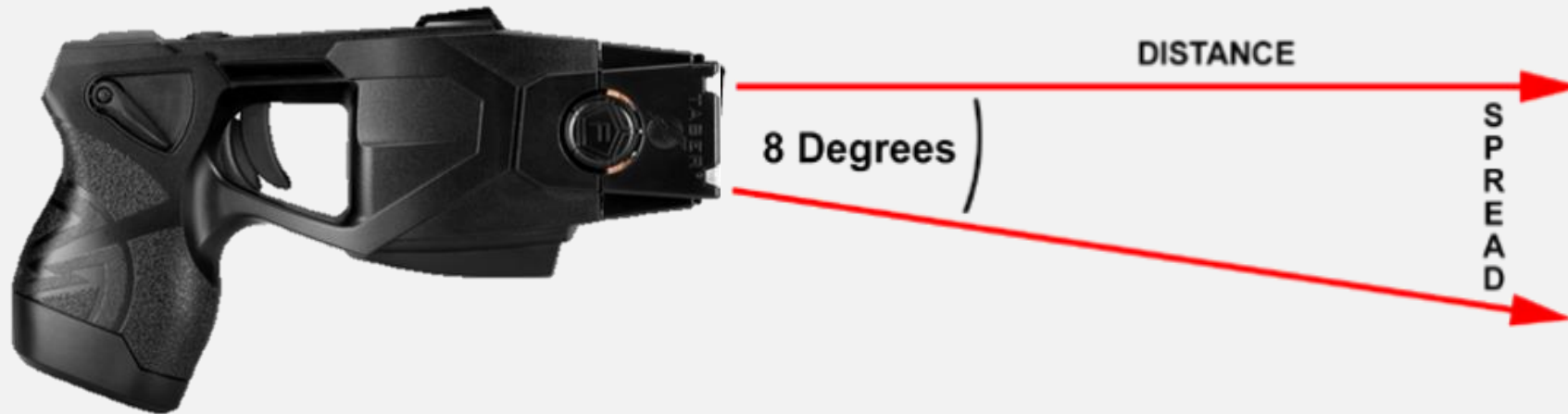

| | | | | | | | | |
|-----------------|------|------|------|------|------|------|------|------|
| | (m) | .6m | 1.5m | 2.1m | 3m | 4.5m | 6.4m | 7.6m |
| Target Distance | (ft) | 2' | 5' | 7' | 10' | 15' | 21' | 25' |
| Spread | (in) | 4" | 9" | 13" | 18" | 26" | 36" | 38" |
| | (cm) | 10cm | 23cm | 33cm | 46cm | 66cm | 91cm | 99cm |

TASER Cartridge Probe Assembly

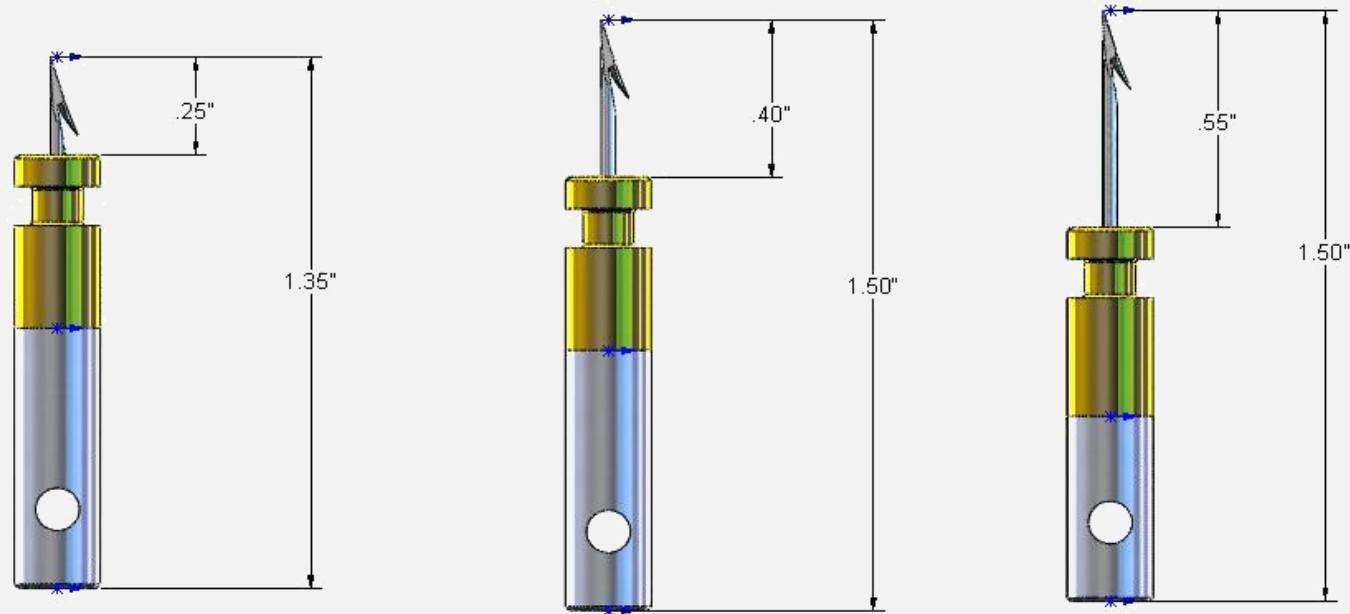

DART ASSEMBLY TRAINING.

DART ASSEMBLY REGULAR.

DART ASSEMBLY XP.

Probe Wires

- Copper Clad Steel with insulated coating
- Can break easily if stepped on or pulled
- Inadvertent contact with wires or the probe during discharge can result in electrical shock
- TASER operator should advise officers to avoid wires during restraint
- Avoid crossing wires when multiple TASER CEWs are deployed

AFIDs

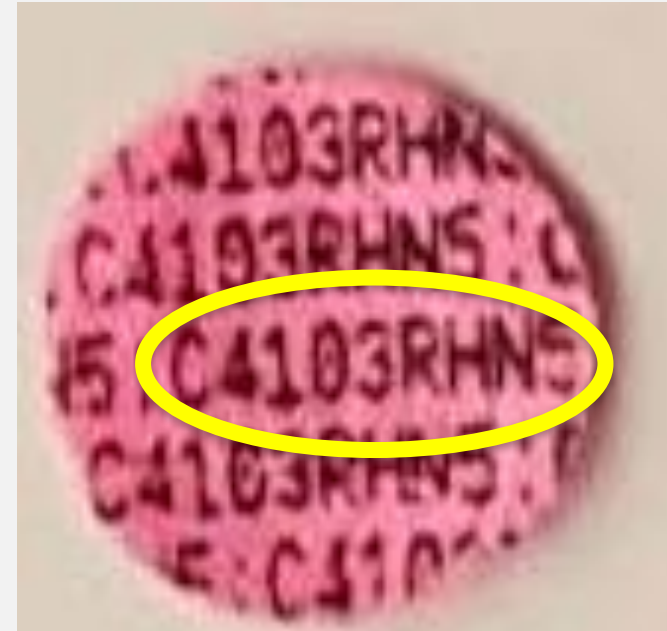

- Each cartridge contains 20-30 Anti-Felon Identification Tags (AFIDs) with the cartridge serial number printed on them

TASER Cartridge Shipping Covers

- On cartridges for safe shipping
- Do not attempt to load a cartridge into a TASER CEW with the cover in place
- Covers should be removed from cartridges prior to being taken into the field

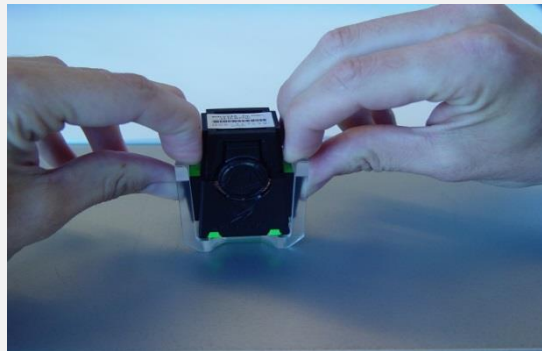

Pull out the sides of the cartridge shipping cover with index and middle fingers



Push up on cartridge with thumbs

Loading TASER Cartridges

- Ensure the safety switch is in the down (SAFE) position
- Point the CEW in a safe direction
- Insert the TASER cartridge into the deployment bay until it is seated
 - **Be cautious of inadvertent cartridge deployment**



TASER Cartridge Failure to Deploy



Always remember to stay on target until the safety switch is shifted to the down (SAFE) position if the cartridge does not immediately fire. And ALWAYS keep the TASER CEW pointed toward the target or in a safe direction.



Basic Cleaning & Troubleshooting

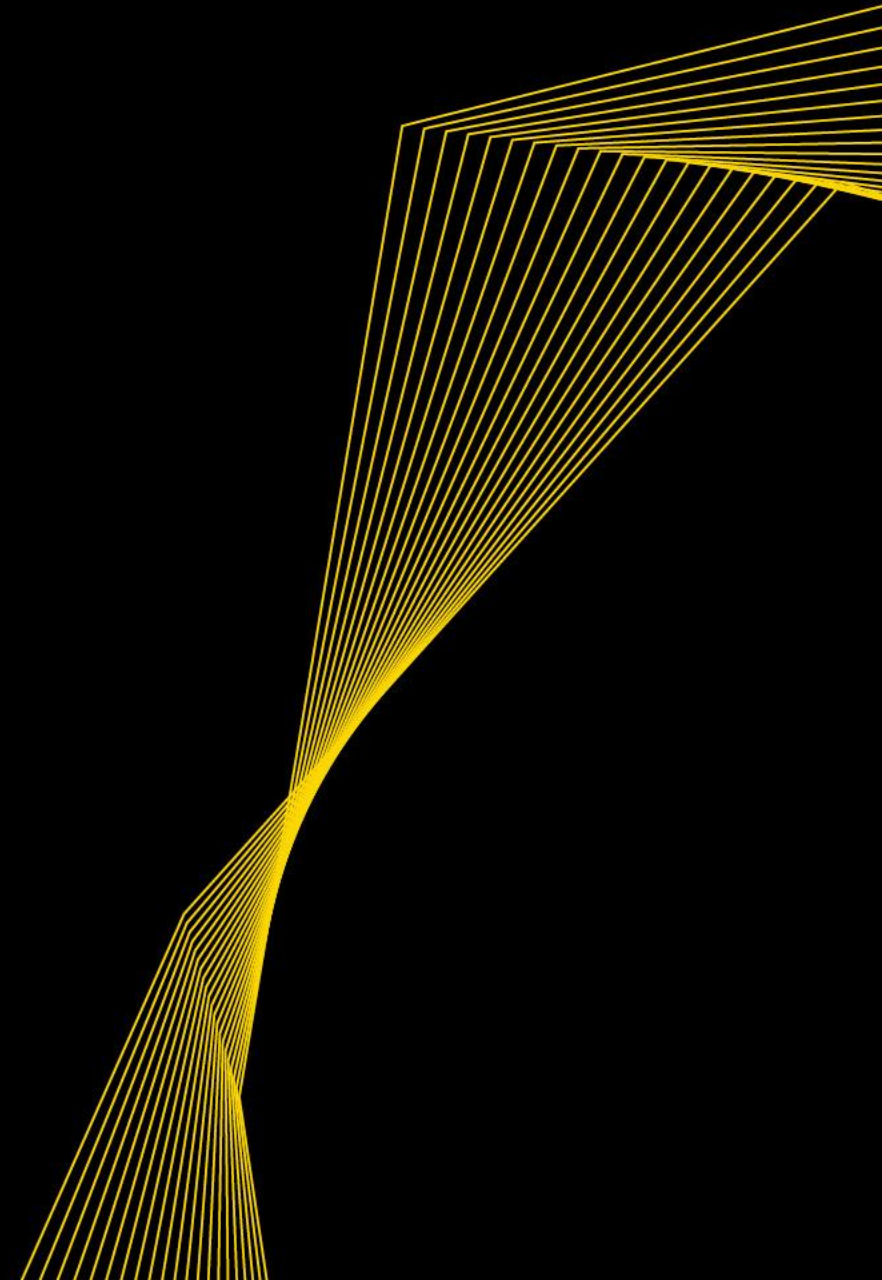

Basic Cleaning of the CEW

WARNING!

- Always ensure that no live cartridges are loaded in a CEW prior to cleaning or maintenance
- **IMPORTANT:** Prior to cleaning any CEW, it is highly recommended that you perform a full download

Basic Cleaning of the CEW

- Periodic cleaning of the outside surface area of the CEW is recommended
- Use a PDI Sanicloth™
- CEWs that are routinely exposed to salt air should be thoroughly cleaned on a frequent basis

Basic Cleaning of the X26P

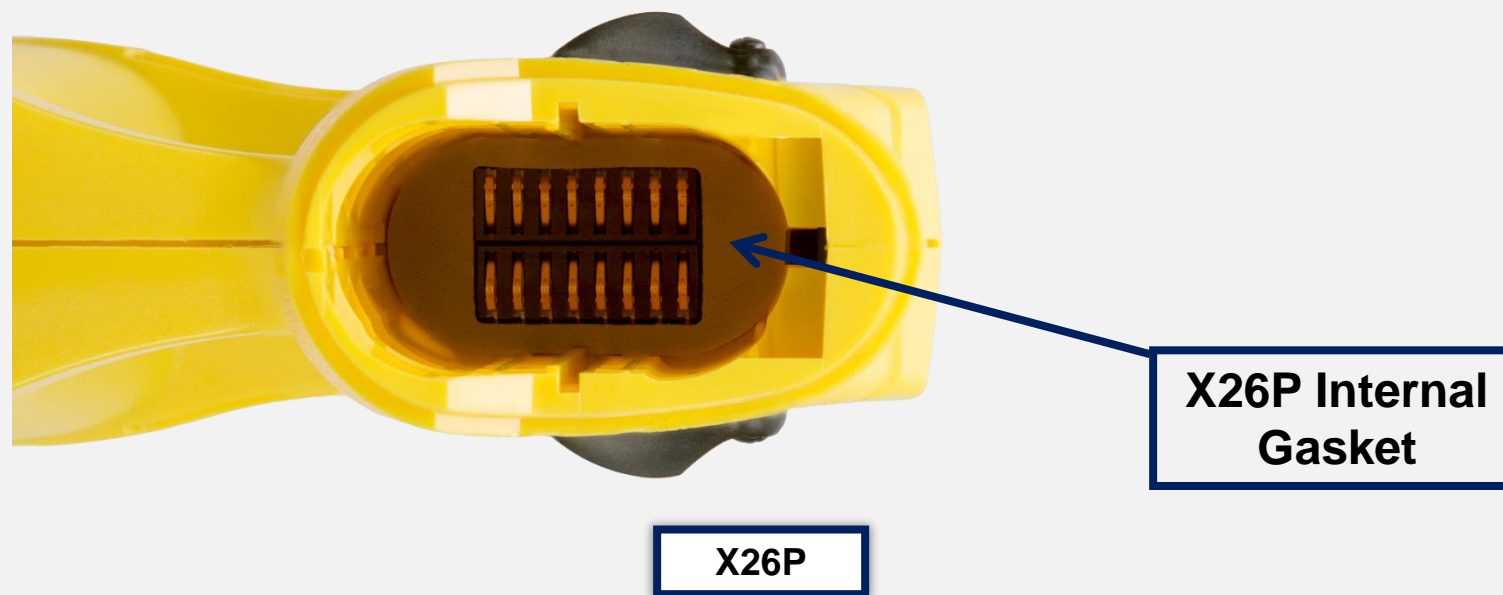

Regardless of which device is being cleaned, care must be taken when working with the contacts within the handle of the device.

Basic Cleaning

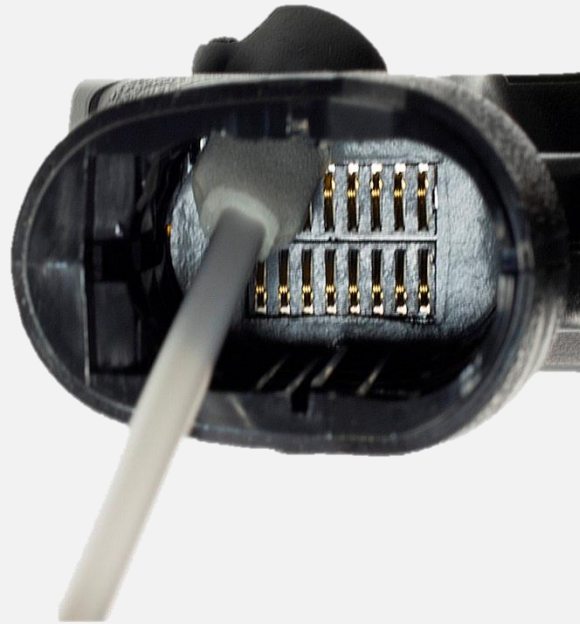

X26P Contacts

- Use an IPA swab to clean the internal battery contacts on the unit
- Gently brush the contact pins with the swab
- DO NOT push the swab stick into the unit with any pressure, doing so may damage the contacts

If working with a newly opened swab, be careful not to force any excess fluid from the tip of the swab into the handle.

Basic Cleaning of the PPM

The battery contacts on CEWs should be cleaned periodically for the highest performance of the CEW and its power source



PPM Contacts

- Use the IPA swab to clean the contacts on the PPM
- You may see a small amount of black (carbon) or white (oxidation) buildup on the contacts – using the swab will help clean this material off and improve contact between the battery and the CEW

In addition to carbon buildup or oxidation, small pieces of dirt or lint can also buildup on the contacts and possibly affect performance.

Cleaning with Compressed Air

Clean CEWs periodically with canned air to remove foreign material like dust and dirt from the contacts



Use canned compressed air only. Do not use an air compressor as this may force moisture into the device.

Cleaning CEW of Biohazards



1. Remove the cartridge
2. Remove the power source (DPM, PPM, etc.)
3. Using the PDI Sanicloth™, wipe the material from the CEW. Make sure to wipe every surface of the CEW including inside the handle
4. DO NOT press too hard into the handle of the unit. Doing so may result in damage to the battery contacts
5. Let the CEW sit for 30 to 45 minutes before replacing the power source
6. After replacing the power source, perform three 5-second spark tests
7. Perform a data download and sync the CEW

Exposure to Water



DO NOT attempt to use a CEW that has been completely submerged in water

- If a CEW gets completely submerged in water, ensure the safety switch is in the down (SAFE) position and remove the cartridge(s) and power source
- Follow the RMA process to submit the CEW to Axon Enterprise

Exposure to Water



Failure to perform the following steps may result in an unintentional discharge when the safety switch is placed in the up (ARMED) position

- TASER CEWs exposed to extreme moisture have discharged with the safety switch still in the down (SAFE) position due to the moisture short circuiting the electronic components
- Cartridges that are exposed to significant moisture must be disposed of in an ESD safe procedure*

Exposure to Water



The following procedure is for those CEWs exposed to a significant amount of moisture but not completely submerged in water.

1. Ensure the safety switch is in the down (SAFE) position and remove the cartridge(s) following the safe procedures outlined in the user manual and training material
2. Remove the power source
3. Wipe down all exposed surfaces including inside the cartridge bays
4. Allow the CEW to air dry for 24 hours before proceeding
 - Warm dry air is preferred – do not use a hair dryer or other external heat source (e.g. microwave oven, etc.)

Exposure to Water

5. After 24 hours, ensure that all components are completely dry; replace the power source
 - Wait one minute before proceeding to the next step. Verify that the CEW is not getting warm or showing signs of short-circuiting
6. Point the front of the CEW away from you, place the safety switch in the up (ARMED) position and observe the CEW
 - If the CEW discharges without pulling the trigger, put the safety switch in the down (SAFE) position, remove the power source and return to TASER via the RMA process if it is still under warranty
 - If the CEW does not discharge without pulling the trigger, conduct three complete sparks tests for a full 5-seconds each to ensure the proper pulse rate and that the cycle stops at 5 seconds

Exposure to Water

7. If the CEW does not operate normally, ensure the safety switch is in the down (SAFE) position and remove the power source
 - Return the CEW to TASER via the RMA process if it is still under warranty
8. If the CEW does function normally, ensure the safety switch is in the down (SAFE) position
 - Download and sync the CEW to ensure the internal time is correct.
 - Ensure that the three spark tests were recorded properly in the download records. Return the CEW to service

Smart Weapon Troubleshooting



WARNING!



- Never perform troubleshooting on a loaded device.
- Always point the CEW in a safe direction and never place hands or other parts of the body in front of the CEW.

Troubleshooting – Major Fault

SYMPTOM

- CID shows a major fault icon



DIAGNOSTIC STEPS

- The X26P detected a fault in the ability to properly log firing events.
- Connect the CEW to Evidence Sync to Synchronize the internal clock and check for firmware updates.
- Return the X26P via RMA noting “Major Fault” in the description if the issue remains.

Troubleshooting – Critical Fault

SYMPTOM

- CID shows a critical fault icon

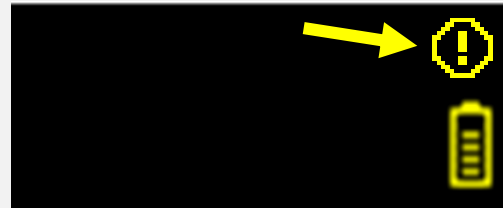

DIAGNOSTIC STEPS

- The X26P detected a problem with the communication with the High Voltage Module.
- As a result, the X26P will not function and must be returned via the RMA process noting “Critical Fault” as the description.

Troubleshooting General Guidance

- Flashlight/LASER inoperable
 - Verify that the CEW is not in stealth mode
 - Verify that these functions haven't been disabled on the CEW by the user
- CID is dim
 - Verify that the CEW is not in stealth mode

Troubleshooting General Guidance

- PPMs are draining quickly
 - Ensure that you are using a TASER approved holster to properly secure the safety switch
 - Remove the PPM during long term storage.

Troubleshooting General Guidance

Update your Firmware!

- Axon continues to make improvements to Smart CEWs, as well as add new functionality.
- A regularly scheduled firmware maintenance process is critical to the sustained life of Smart CEWs.
- All CEWs should be programmed with the updated firmware ASAP
- Failure to update firmware could affect Smart CEWs performance and shorten its useful life

X26P Troubleshooting

SYMPTOM

- No spark when trigger is pulled
-

DIAGNOSTIC STEPS

- Verify that the X26P has the latest firmware.
- Replace with a new PPM.
- Point the X26P in a safe direction and turn safety switch to the up (ARMED) position.
- Press trigger.
- If the X26P sparks with trigger pull then the issue was with the old PPM.
- If the X26P does not spark with trigger pull, return via RMA.



CEW Smart Use Considerations

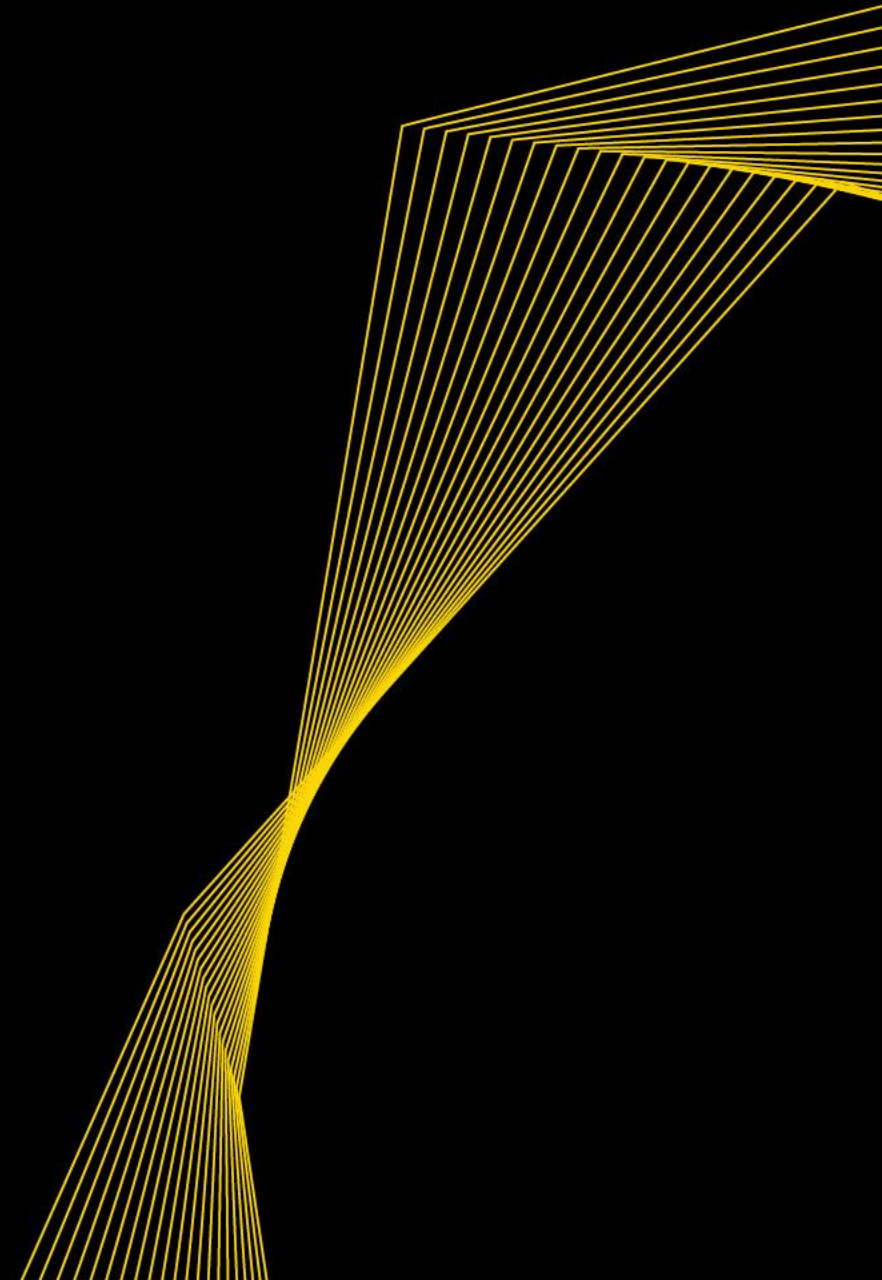

4th Amendment Standard

- All officers must comply with the 4th Amendment when using TASER CEWs
- It is up to your agency to set its own policies for the use of TASER CEWs, which may be more restrictive than the Fourth Amendment standard
- TASER provides Smart Use Considerations for the use of TASER CEWs, but does not set the standard

4th Amendment Standard

Graham v. Connor, 490 U.S. 386 (1989)

- Officer's force must be objectively reasonable under the totality of circumstances as reasonably perceived by the officer at the moment the force is used
- 3 Main Factors:
 - the severity of the crime at issue
 - whether the suspect poses an immediate threat to the safety of the officers or others
 - whether subject is actively resisting arrest or attempting to evade arrest by flight

CEW Smart Use Considerations

- Force decisions must reasonably consider (as time and circumstances permit):
 - Subject's actions/behaviors the officer is attempting to stop, thwart, or control
 - Foreseeable risks of injuries/harm to subject from force to be used

CEW Smart Use Considerations

When Reasonable:

- Use the minimum force necessary to accomplish lawful objectives
- Use force only on those “**actively resisting**” or higher
- Give a verbal warning before the use of force
- Give subjects a reasonable opportunity to comply before force is used or repeated
- Immediately cease any force once a subject is under control

CEW Smart Use Considerations

- Ensure CEW use is within:
 - Law (correctly applied legal standards of care) and
 - Within policy and training

- Do not use CEW for:
 - verbal defiance
 - belligerence
 - punishment
 - horse play

CEW Smart Use Considerations

- Follow “targeting guidelines” when feasible, avoiding the chest and splitting the beltline for close-range shots
- Use 5-second “window of opportunity” to restrain and “cuff under power”
- Be able to justify every CEW trigger pull or 5-seconds of discharge under the specific circumstances presented

CEW Smart Use Considerations

- Avoid repeated or continuous CEW exposures unless necessary to counter immediate threat
- Avoid using CEW on vulnerable or higher risk populations (e.g. small children, elderly, pregnant) unless necessary to counter immediate threat
- Monitor subject post-CEW use. As with any use of force, if subject is unresponsive, initiate EMS/CPR protocols

CEW Smart Use Considerations

- Avoid using CEW drive stuns *except*:
 - 3 or 4-point contact to complete circuit or increase probe spread
 - “break-contact” or distraction tactic create reactionary distance
 - brief application to attempt pain compliance
- Do not repeat drive stuns if compliance not achieved
- Do not use drive stuns if pain is unlikely to gain compliance due to mind-body disconnect (psychotic episode) or increased pain tolerance (drugs/alcohol)



Brief Overview of Select Medical and Safety Findings

*Review TASER's CEW Research Index and other
documents and materials on Axon's website*

Cardiac

Experts have identified the following key factors related to CEW cardiac risks:

- Dart-to-heart distances
- Amount of delivered electrical charge

The further the CEW dart is away from the heart and the fewer CEW cycles applied, the lower the risk of the CEW affecting the heart

Cardiac

CEW cardiac risks are low, but not zero

To reduce cardiac risks (when possible):

- Target the back
- Avoid targeting the chest
- Avoid repeated or continuous exposures

Physiologic/Metabolic Effects

CEWs may produce effects that could increase the risk of sudden death, including changes in:

- Blood chemistry
- Blood pressure
- Respiration
- Heart rate and rhythm
- Adrenaline and stress hormones

The longer the CEW exposure, the greater the potential effects. Use reasonable efforts to minimize the number and duration of CEW exposures

Physiologic and metabolic effects

Studies show CEW effects are usually comparable to or less than:

- Fighting
- Fleeing

Numerous human studies have shown lower CEW effects on human physiology compared to some other force options

Avoid Extended or Repeated Applications

Each trigger pull must be legally justified

- Use the shortest duration of CEW exposure necessary to accomplish lawful objectives
- Reassess the subject's behavior before repeating or continuing the exposure, and provide breaks in the CEW stimulation when practicable
- Several law enforcement groups (e.g. IACP, PERF, COPS, DOJ) have established 15 seconds of CEW exposure (multiple applications or continuous) as a significant safety point

Higher Risk Populations

CEWs, like other force options, have not been laboratory tested on:

- Pregnant women
- Elderly
- Small children
- Low body-mass index / very thin persons

CEW use on these individuals could increase the risk of death or serious injury

Medically Compromised Persons

- Any law enforcement use of force, including a CEW, may cause or contribute to death or serious injury
- Law enforcement personnel are called upon to deal with individuals in crises that are often medically compromised and who may be susceptible to arrest-related death
- The subject may already be at risk of death or serious injury as a result of pre-existing conditions, individual susceptibilities, or other factors
- **Follow your agency's guidance and policies when dealing with medically compromised persons**

Independent Conclusions

All CEW users are encouraged to do their own research and analysis

Some of the latest CEW research can be viewed at:

<https://www.axon.com/legal>

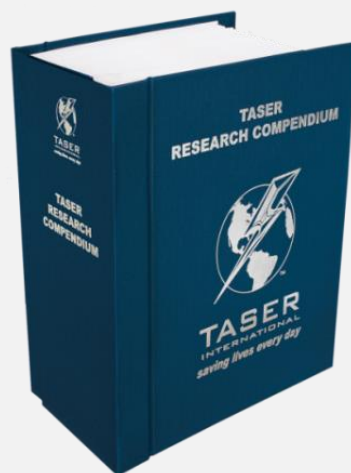



Tactical Considerations



Holster: Pros & Cons

| Support Side Carry | Dominant Side Carry |
|---|--|
| + Lower Risk of Drawing Wrong Weapon Under Stress | + Weapon Retention |
| + Hip crossdraw = Faster Engagement on Target | |
| + Easier ID as a CEW By Other Officers | Higher risk of weapon confusion |
| Weapon retention issues, depending on DT training | Known incidents of shootings by mistaken weapon confusion |
| <i>Refer to your department's tactical experts to make your own policy on how to carry, holster, and deploy the TASER CEW</i> | |

Probe Placement

Effectiveness is directly related to probe spread and probe location

- Greater probe spreads increase effectiveness
- Probe spreads typically are more effective if one probe is above and the other probe is below the beltline

Preferred Target Zone Rear (when possible)

Below neck (blue zone)

- Large muscles
- Avoid head

The back is always the preferred target area when reasonably practicable



Preferred Target Zone Front (when possible)

Lower torso (blue zone below chest)

- More effective
 - Larger muscles
 - Split the beltline
- Reduces risk of hitting sensitive body areas (see product warnings)
- Increases dart-to-heart safety margin distances
- Do not intentionally target genitals



Probe Placement

- If practicable, deploy probes in preferred target zones of suspect's back:
 - Clothing fits tighter
 - Surprise factor
 - Stronger muscles – usually even more overwhelming
- SP cartridges are more effective in reducing clothing disconnects
- Keep CEW in line with target
 - Vertical vs. Horizontal (subject lying down)
- Get both probes in preferred target zones

Probe Placement

Avoid intentionally targeting the CEW on sensitive areas of the body such as the head, throat, breast, chest or area of the heart, genitals, or known pre-existing injury areas without legal justification



TASER Conductive Targets

Conductive full-size targets available from TASER

- Preferred target zones
- Auditory feedback
- Allows targeting of lower body and legs
- Practice splitting the beltline

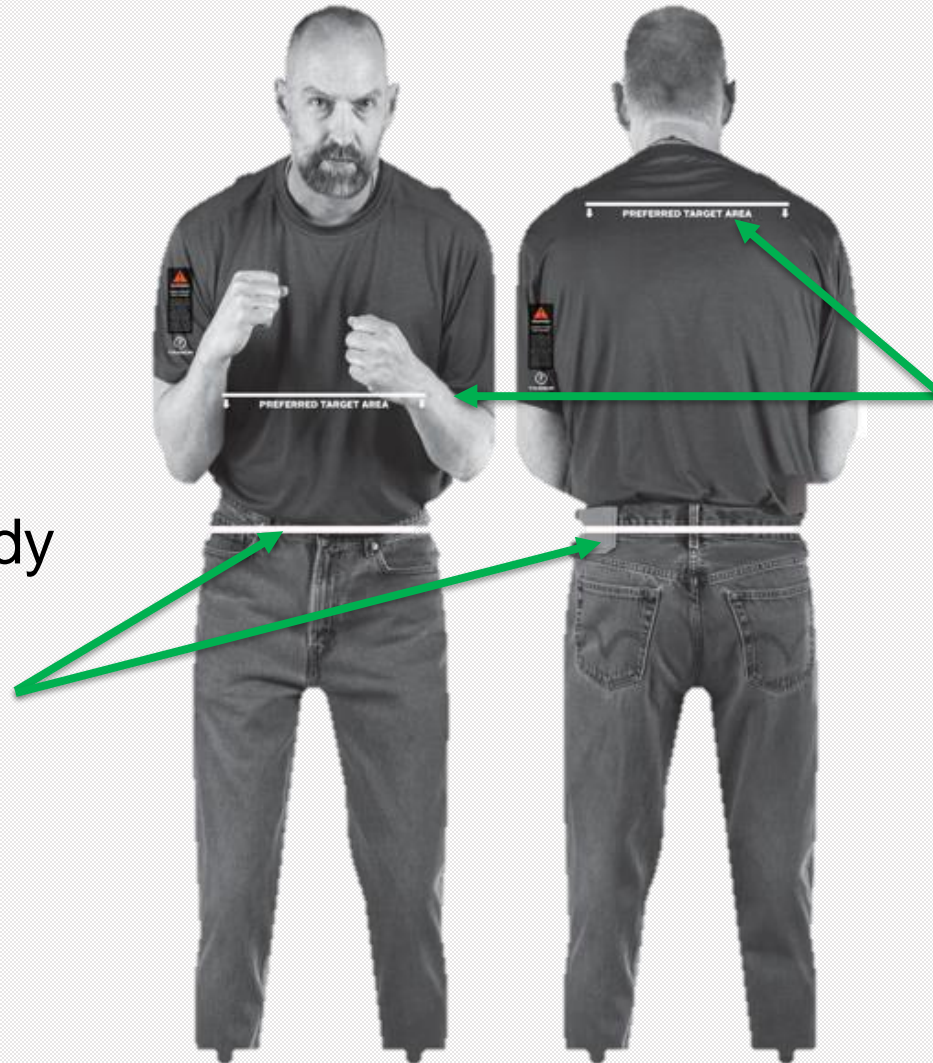

Upper limit of preferred target zone

Tactical Considerations

- Have reasonable and appropriate force options available when practical
- Consider cover and distance tactics
- When practical:
 - have at least one back-up officer present to control/cuff under power
 - consider landing zone

Injuries From Falls

NMI frequently causes subject to fall

- Falls are often uncontrolled and subject is often unable to protect or catch himself
- Falls, even from ground level, can cause serious injuries or death (especially on a hard surface)

Tactical Considerations

- **Keep** sufficient slack in the wires
- **Move** with the subject if he starts to roll
- **Consider:** If only one probe hits or low probe spread, consider drive stun follow-up with cartridge still in place

Be Careful of Distractions

- There are incidents/cases where officers have been accused of using excessive CEW exposures caused by distractions (including by nearby family members, bystanders, incident witnesses), stress, etc.
- Be alert to and avoid potential or occurring distractions that may result in unnecessary additional 5-second CEW cycles or extended exposures

Deployment Distance Considerations

Deployments from 0-7 feet (0 – 2 meters)

- High hit probability BUT limited probe spread
- Split the beltline to increase effectiveness
- A minimum 12-inch probe spread is optimal



Small Probe Spread Video

Video Learning Points

- Voluntary exposure with small probe spread on the back of the left leg
- Subject feeling the effects of the cycle, however still able to deliver effective baton strikes

Small Probe Spread Video



Close Distance Video

Video Learning Points

- Both probes in the chest
- Little spread
- Some effect but not NMI
- Subject able to pull out probes

Close Distance Video

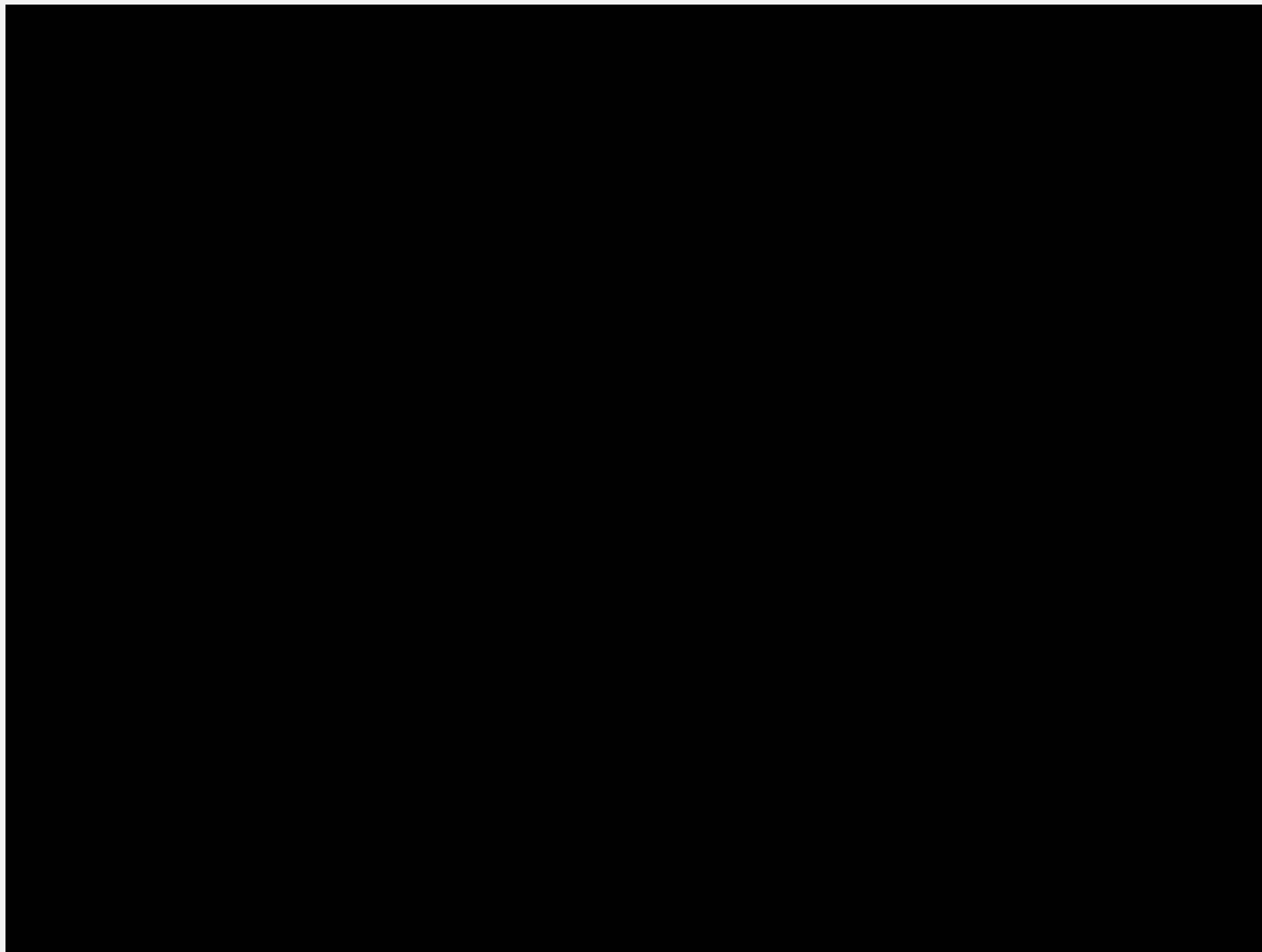

Close Quarters Video

Video Learning Points

- Small civil courtroom
- Suspect, victim and witness very close
- Bailiff deploys X26 at very close range
 - Initially forgot to arm the X26
 - Avoids victim and witness
 - Suspect incapacitated and held until backup arrives
- Would baton or pepper spray have been a good option?

Close Quarters Video



Deployment Distance Considerations

Deployments from 7-15 feet (2 – 4.5 meters)

- Optimal distance
- Good hit probability with both probes
- Greater probe spread
- Slack in wires
- Large reactionary distance

Deployment Distance Considerations

Deployments from 15 – 25 feet (4.5 – 7.6 m):

- May be out of range of 15/21' cartridges
- Fair hit probability with both probes
- Large probe spread = large amount of muscle affected
- Less slack in wires
- Larger reactionary distance

Some Causes of Limited Effectiveness

- Miss or single dart hit
- Close probe spread
- Incomplete, broken, or intermittent circuit
- Loose or thick clothing
- Low nerve or muscle mass
- Obese subject
- Wires break, touch each other, or fall on a conductive surface
- Operator error

Look for a Change in Behavior

- Look AND listen when evaluating the effectiveness of a CEW deployment
 - Watch the subject's reaction
 - Look for a change in behavior
- Loud arcing sound typically indicates NO connection
- Intermittent arcing typically indicates a poor connection such as a clothing disconnect

Intermittent Connection

Video Learning Points

- Voluntary exposure in conjunction with CEW training
- Volunteer is wearing a loose fitting shirt
- Spotters lower him immediately after the deployment, effectively closing the distance between the bottom probe and the volunteer's skin

Intermittent Connection



Contingencies

- CEW may have limited or no effect
- No weapon system will operate or be effective all of the time
- A CEW or cartridge may not fire or be effective
- Reload new cartridge and re-engage if legally justified
- Employ other force options, other alternatives, or disengage

Ineffective Front Shot Video

Video Learning Points

- Thick, loose clothing on upper torso
- OC deployment prior to CEW usage failed to achieve compliance
- No discernable effect from CEW
- Officers transitioned to hands-on

Ineffective Front Shot



Flammability

- TASER CEW can ignite explosive materials, liquids, fumes, gases, vapors, or other flammable substances

(Gasoline, sewer gases, meth labs, flammable personal defense sprays, hair gels, butane lighters, etc.)

- Some propulsion agents (carriers) are flammable
- Do not deploy a CEW in conjunction with flammable personal defense sprays

Note: Test to make sure your personal defense spray is not flammable

Increased Deployment Risk Examples

Subject:

- On an elevated position or platform
- Running or under momentum
- Operating vehicle or machinery
- In flammable or explosive environment
- Obviously pregnant
- In water, mud, muck (drowning risk)
- Sensitive target areas
- Obviously frail or infirm
- Low body mass
- Probes in heart or chest area
- Extended, repeated, or continuous discharges

Water Deployment Video

Video Learning Points

- Emotionally disturbed subject standing next to an in-ground swimming pool
- Firearm lying at his feet on pool deck
- Above and below the beltline shot placement
- Officers entered same body of water as the subject during the cycle

Water Deployment Video



Single Officer Deployment

Video Learning Points

- No immediately available handcuff/control officers
- Apparent effective CEW front shot
- What to do with the CEW immediately after the deployment?
 - Re-holster? Does your CEW holster maintain wire integrity?
 - Lay the CEW on the ground?
 - Await back-up if available?

Single Officer Deployment



Controlling/Cuffing Under Power

You can go hands on with the subject during the 5-second cycle without feeling the effects of NMI.

- Electricity generally follows the path of least resistance
- Use each 5-second cycle as a "window of opportunity" to control/cuff while the subject is affected
- Cuffing under power can reduce the need for repeated or extended CEW exposures

Control and Cuffing under power Video

Video Learning Points

- Subject with a knife
- Several Use of Force option back-up/cover officers
- TASER CEW deployed to subjects back area
- Controlled and cuffed under power

Control and Cuffing under power Video



Inmate Under Power Video

Video Learning Points

- Consideration given to splitting the belt line
- Handcuff/Control officers readily available
- Good verbal communication

Inmate Under Power Video



Suicidal Subjects

- Follow your agency's policy and basic officer safety rules/training when dealing with suicidal subjects
- CEWs may be an effective way to deal with suicidal subjects
- The CEW is NOT a substitute for deadly force
- Establish deadly-force cover as needed and available

Suicidal Man with a Knife De-escalation Video

Video Learning Points

- Subject with a knife
- Several Use of Force option back-up/cover officers
- Clear commands in attempt to de-escalate

Suicidal Man with a Knife De-escalation Video



Subject with a Knife De-escalation Video

Video Learning Points

- Subject with a knife
- Several Use of Force option back-up/cover officers
- Clear communication in attempt to de-escalate

Subject with a Knife De-escalation Video





Drive Stun

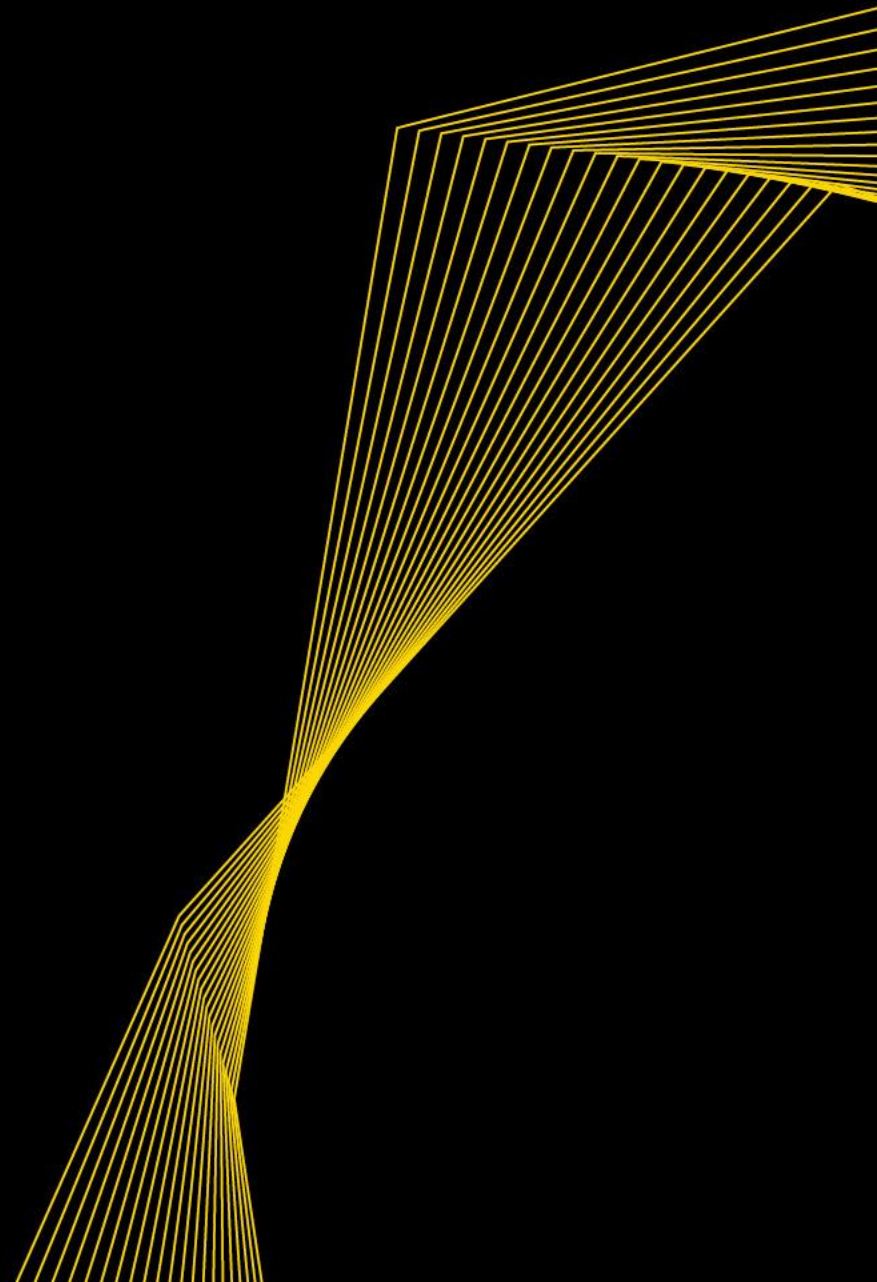

Probe Deployment vs Drive Stun

Probe deployments are more desirable/effective than drive stuns (other than 3-point deployments)

- NMI vs. pain compliance
- Can be applied from a safer distance
- Usually require fewer cycles

Drive Stun

- Use care when applying the drive stun near the neck or groin (yellow)
- Avoid areas that can be easily crushed like the trachea (red), the back of the neck, and the genitals
- Follow agency policy



Drive Stun

- To use the drive stun without deploying the probes, remove the live cartridge
- If not effective, transition to alternative force option
- Do not hold on to a live cartridge while applying a drive stun. If cartridge gets within approximately 2 inches of the CEW, it may deploy

Drive Stun with Live Cartridge

Can be effective

- Probes may not deploy if in direct contact with the subject
- Will not cause NMI

Alternative

- Deploy probes at close range and apply (3-4 point) drive stun away from probe impact sites to increase NMI potential



Animals

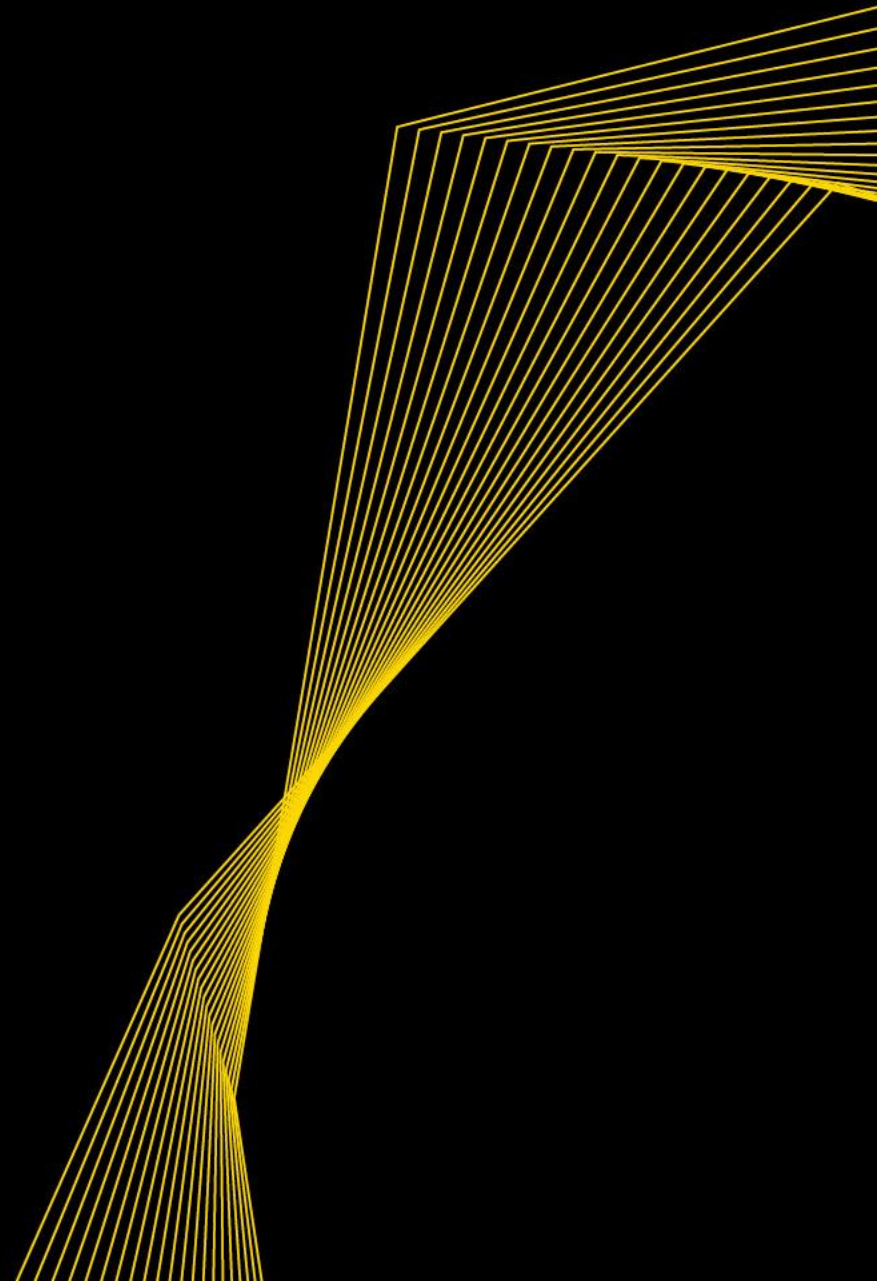

Effects on Animals

If CEW's are used on animals, consider having animal control stand by to apply a restraint during the cycle

Animal Use Video



Police/Military K-9 Caution

- If K-9 bites probe or between probes during CEW deployment, the dog may receive a shock
- An electrical shock to a K-9 may result in a hesitant, hesitating, or bite adverse K-9
- Develop procedures and train K-9 handlers and CEW operators on this issue



Post Incident

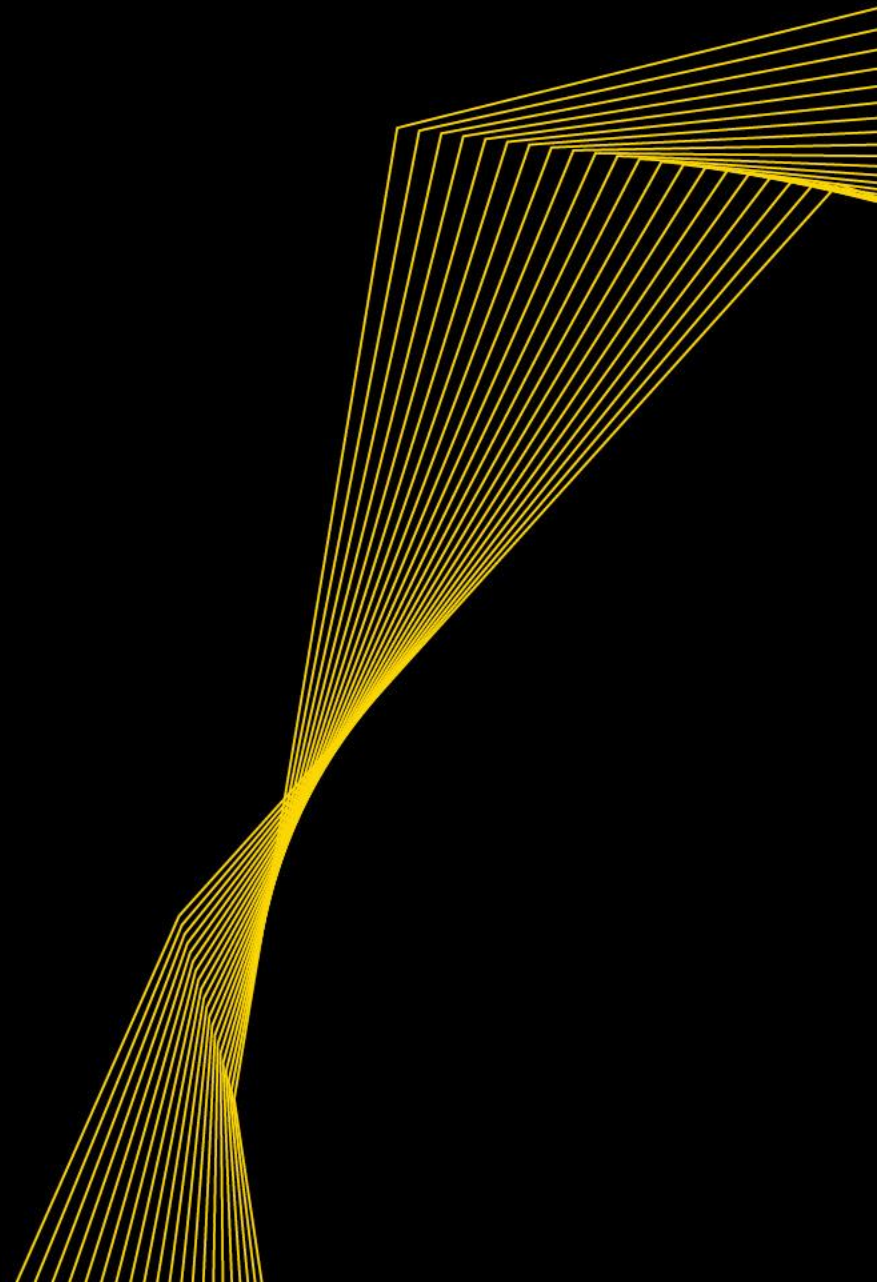

Post Incident

- Record incident from officer's point of view
- Fully document
 - Subject's threats, behaviors, and actions
 - Each application of force
 - Each CEW trigger pull or 5-second discharge
 - Each injury or alleged injury

Post Incident

- Consider using your radio to establish record of significant events with dispatch time logs (call in):
 - Immediately at end of CEW use
 - Immediately upon subject being handcuffed
- Monitor subject's medical condition and report any changes
- As with any use of force, if subject is unresponsive, initiate EMS/CPR protocols

Probe Removal Policy Considerations

- May officers remove probes?
 - Common probe penetration
 - Sensitive location probe penetration
 - Uncommon probe penetration
- Proper handling of removed probes
 - Bio-hazard
 - Evidentiary value

Probe Removal Follow-up

- Note if probes penetrated skin
- Photographs of impact site and injuries
- Medical follow-up
- Ensure probe and barb are intact

Considerations for Handling Used Probes (Field Deployments)



Factors to be considered include:

- Unanticipated probe-related injury
- Probe in sensitive area
- Deeper embedment of probe due to movement, body position, or pressure on probe
- Evidence collection, proper storage, and retention*

Considerations for Handling Used Probes (Field Deployments & Training)



- Treat probes that have penetrated the body as contaminated needles (use gloves)
- Grab probe firmly and quickly pull (pluck) straight out (consistent with agency policy)
- Carefully place used probes sharp-tip first into either a sharps container or into the cartridge side wire pocket container, secure in place, and place in a secure location where no one will accidentally touch probes

Evidence Collection

Consider (consistent with legal requirements and agency policy):

- Photographing injuries, probe impact or energy arcing sites or contact points
- Collecting cartridge, probes, AFIDs
- TASER CEW Evidence Collection and Analysis Course

Critical Event Assistance

- A Critical Events contact form can be submitted through:
 - <https://returns.axon.com/CriticalEventsForm.aspx>
- Once submitted (law enforcement only), you will be contacted as soon as possible by a Axon representative.
- **While you wait for our response, please download the [Critical Event Checklist](https://returns.axon.com/Documents/CriticalEventsForm/Critical-Event-Checklist.pdf) .**
 - <https://returns.axon.com/Documents/CriticalEventsForm/Critical-Event-Checklist.pdf>



Evidence Sync and Evidence.com



Evidence.com

Evidence.com is a program offered by Axon that makes it easy for agencies of any size to manage CEW related material, collect, transfer, manage, retrieve and share any form of digital evidence.

There are two versions available:

- Evidence.com Lite – free version
- Evidence.com Pro – fee based subscription program

What is Evidence Sync?

- Evidence Sync is a free program offered by Axon Enterprise that allows agencies to perform a myriad of functions with their TASER products
 - Access CEW firing data and Axon videos
 - Update firmware on CEWs and Axon cameras
 - Assigning CEWs and Axon cameras to individual users, etc. in conjunction with your agencies Evidence.com account

Quarterly Downloads

- TASER Training recommends that these downloads be conducted on a quarterly basis, at a minimum
- This recommendation is based on the following overall goals:
 - Verify that the CEW has the most recent firmware installed.
 - Check the overall condition and functionality of the CEW; including spark rate, power source level and presence of any fault icons
 - Validate that recommended pre-shift or daily functionality/spark tests are being conducted via the CEW firing records
 - Retention of CEW firing records

Evidence Sync

SYNC Uploads Help

EVIDENCE SYNC™

Online 3.15.79 Cousins, Lamar (0837) [Sign out](#)

Upload Queue

Devices



X12003N2C
Cousins, Lamar (0837)
Firmware: 04.032

[PDF report](#)

Folders

Search

- ★ Favorites
 - Desktop
 - Downloads
 - Recent Items
- Libraries
 - CameraRoll
 - Documents
 - Music
 - Pictures
 - SavedPictures
 - Videos
- Computer
 - C:
 - Training (T:)

Logs

Filters: [OFF](#) From: [07:00](#) [26 August 2015](#) To: [04:00](#) [26 December 2017](#) Events: [All](#)

| # | Local Time | Event | Duration | Temp | Batt % | Graphs | |
|----|----------------------|-----------------------|--|-------------|-----------------------|------------------------|--|
| 65 | 03 Sep 2017 18:47:11 | Safe | 7s | 34°C | 83% | Graphs | |
| 66 | 03 Sep 2017 18:57:12 | Armed | | 34°C | 83% | Graphs | |
| 67 | 03 Sep 2017 18:57:42 | Trigger | 5s | | 83% | Graphs | |
| 68 | 03 Sep 2017 18:57:50 | Trigger | 5s | | 83% | Graphs | |
| 69 | 03 Sep 2017 18:57:59 | Safe | 47s | 37°C | 83% | | |
| 70 | 03 Sep 2017 19:30:50 | USB Connected | | | | | |
| 71 | 03 Sep 2017 19:30:51 | Time Sync | 03 Sep 2017 19:30:51 to 03 Sep 2017 19:30:51 | | | | |
| 72 | 08 Nov 2017 00:48:02 | Armed | | 28°C | 80% | | |
| 73 | 08 Nov 2017 00:48:04 | Safe | 2s | 27°C | 80% | | |
| 74 | 08 Nov 2017 00:48:45 | Power Magazine Change | APPM | S/N: 625366 | Battery capacity: 95% | | |
| 75 | 08 Nov 2017 00:48:45 | Armed | | 28°C | 95% | | |
| 76 | 08 Nov 2017 00:48:52 | Trigger | 5s | | 95% | Graphs | |
| 77 | 08 Nov 2017 00:48:57 | Safe | 12s | 29°C | 95% | | |
| 78 | 08 Nov 2017 01:21:43 | USB Connected | | | | | |

[PDF Report](#)

Device Settings

Graphs available in online mode only

Trilogy™ Logs

The purpose of the following slides is to provide various examples of Trilogy logs, which may be encountered by CEW users and their agencies.

The Trilogy logs consist of:

- Event log: When did the event happen?
- Pulse graph (log): What was the electrical energy output during the event (by the CEW)?
- Engineering log: How was the CEW performing during the event?

Event log

The Event log tracks events. An event begins when the safety is moved to the up (ARMED) position and ends when it is moved to the down (SAFE) position. The Event log also stores deployment events for each cartridge bay: cartridge type, deployment status (whether the cartridge actually deployed or not), trigger pull vs. ARC switch activation, duration of cycle, date, and time.

The Event log also stores system configuration change events: (e.g. if the date, time, time sync, LASER, or flashlight settings are viewed or changed).



Taser Information

| | |
|------------------|----------------------------|
| Dept. | Master Instructor Training |
| Serial | X3000087N |
| Model | TASER X2 |
| Firmware Version | Rev. 04.032 |
| Device Name | X3000087N |
| Health | Good |

Report Generated by

| | |
|----------------|-------------------------------------|
| Name | Cousins, Lamar |
| Badge ID | 001 |
| Local Timezone | Mountain Standard Time (UTC -06:00) |
| Generated On | 30 Aug 2017 00:07:49 |

Device (X2)

| Seq # | Local Time [dd:mm::yyyy Hr:min:Sec] | Event [Event Type] | Cartridge Information [Bay:length in feet/status] | Duration [Seconds] | Temp [Degrees Celsius] | Batt Remaining [%] |
|-------|-------------------------------------|--------------------|---|--------------------|------------------------|--------------------|
| 1 | 13 Jul 2017 08:13:53 | Armed | C1: 25' Standard C2: 25' Standard | | 28 28 | 75 75 |
| 2 | 13 Jul 2017 08:13:54 | Trigger | C1: Deployed | 1 | | 75 |
| 3 | 13 Jul 2017 08:13:54 | Trigger | C2: Deployed | 1 | | 75 |
| 4 | 13 Jul 2017 08:13:55 | Safe | C1: Deployed C2: Deployed | 2 2 | 28 28 | 75 75 |
| 5 | 13 Jul 2017 13:28:15 | Armed | C1: 25' Standard C2: 25' Standard | | 28 28 | 75 75 |

Pulse Graph

- Pulse graph records pulse activity from trigger pulls and warning Arc displays.
- Pulse graph data does not reflect actual voltage or charge delivered into a target. In other words, the energy is metered at the weapon and the energy delivered to the target will ALWAYS be less than when it leaves the weapon due to various levels of resistance.

Pulse Graph

- The “Arc” and “Stimulation” information in the Pulse graph provide information intended to illustrate the CEW’s ongoing efforts to achieve a complete circuit. The Arc and Stimulation portions of the graphs indicate the “Arc” and “Stimulation” in voltage (labeled on the left side of the graph)
- The “Charge” portion of the graph often provides the most beneficial information to the end user by indicating whether or not a complete circuit has been achieved. The Charge portion of the graph indicates the charge in microcoulombs (labeled on the right side of the graph) as determined by electronic circuitry inside the CEW; the data does not reflect actual charge delivered into the target

Event Log and Pulse Graph Example

Event log
PDF

| Seq # | Local Time [dd:mm::yyyy Hr:min:Sec] | Event [Event Type] | Duration [Seconds] | Temp [Degrees Celsius] | Batt Remaining [%] |
|-------|--|-----------------------|-----------------------|---------------------------|-----------------------|
| 6 | 28 Jun 2013 14:31:03 | Armed | | 27 | 83 |
| 7 | 28 Jun 2013 14:31:05 | Trigger | 6 | | 83 |
| 8 | 28 Jun 2013 14:31:12 | Safe | 9 | 29 | 83 |

Pulse graph

Pulse Log Graph

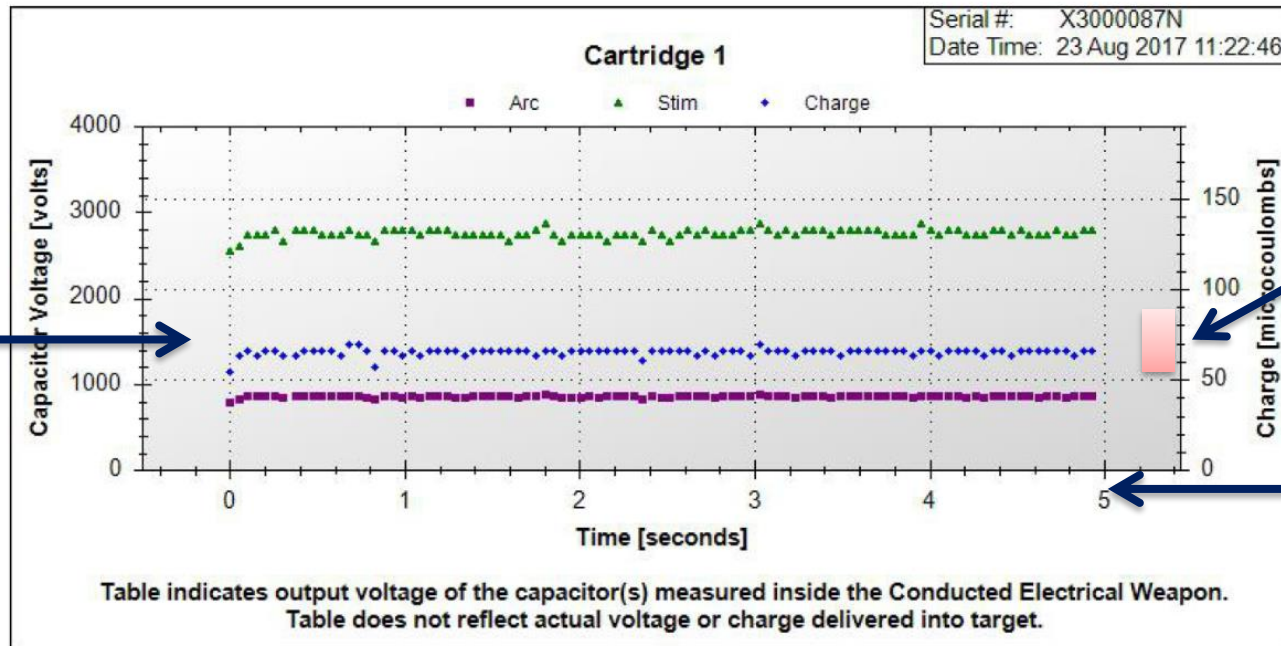

Charge

Charge is within
TASER specified
tolerance range

Graph indicates
duration was 5
seconds

Pulse graphs

- The following slides are intended to provide various examples of voluntary exposures and the graphs that resulted
- These slides are not intended to illustrate Pulse graphs that may be generated by usage in the field
- Users are encouraged to pay particular attention to how the Pulse graphs vary and how they differ from video-to-video (e.g. exposure-to-exposure)

X26P Single Probe Hit – Drive-Stun Follow Up



X26P Single Probe Hit – Drive-Stun Follow Up

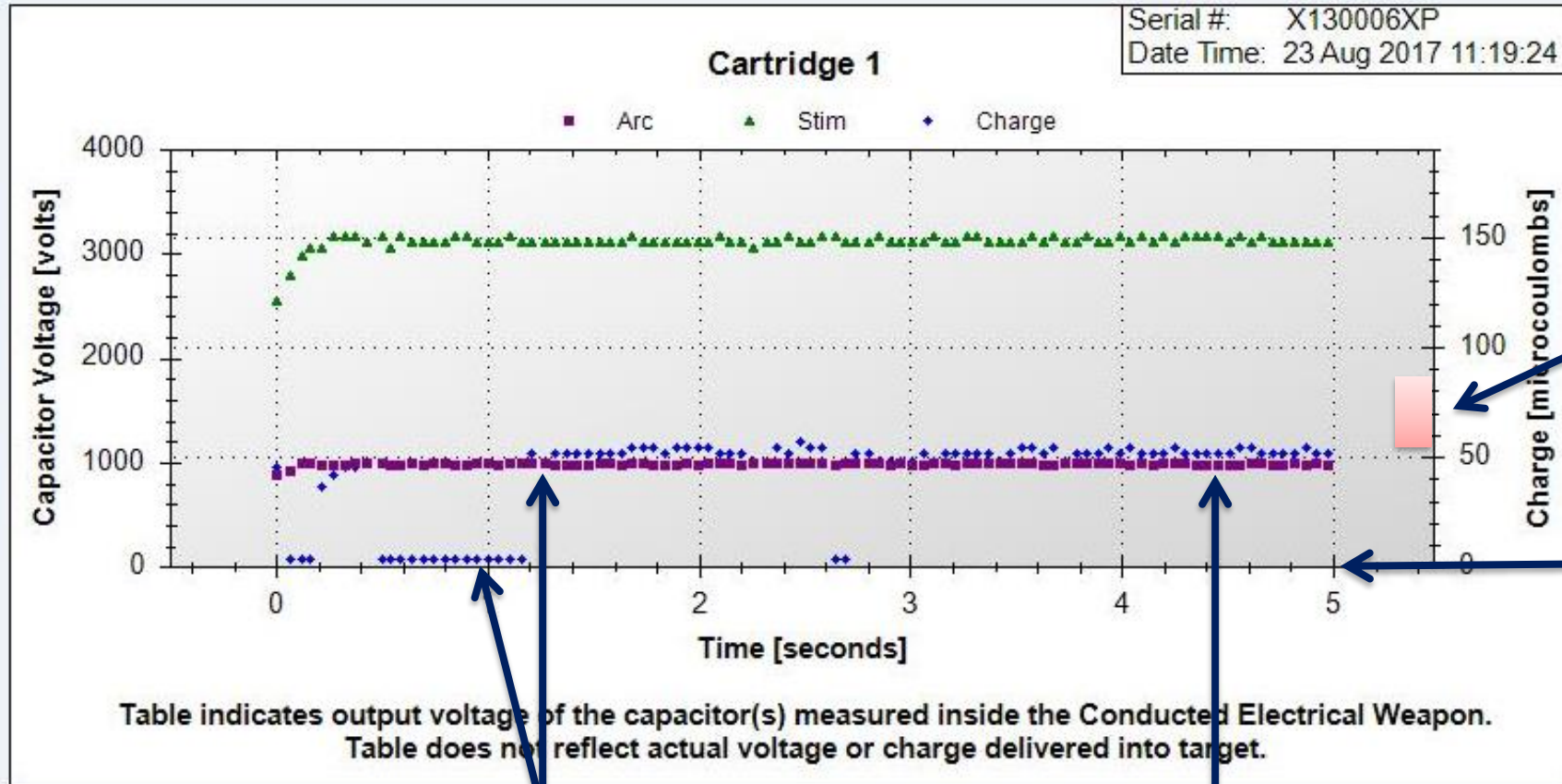

Charge is within
TASER specified
tolerance range

Graph indicates
duration was 5
seconds

Charge suddenly elevates, typically
indicating there was prior disconnect;
followed by a connection in the circuit.

Good output indicates
a complete circuit

Open Circuit - Change in PPS

- Smart Weapon firmware 4.029 allows the PPS rate to drop to approx. 9 PPS upon detection of an open circuit
- Designed in an effort to improve the service life of the X26P
- Upon detecting a closed circuit, the PPS immediately returns to 19 PPS

Open Circuit - Change in PPS

- This PPS reduction will only take place during an open or incomplete circuit (e.g. single probe hit, clothing disconnect, etc.)
- This change in PPS will not affect daily functionality checks, drive-stuns, or effective probe deployments

Open Circuit - Brief Clothing Disconnect



Open Circuit - Brief Clothing Disconnect

Pulse Log Graph

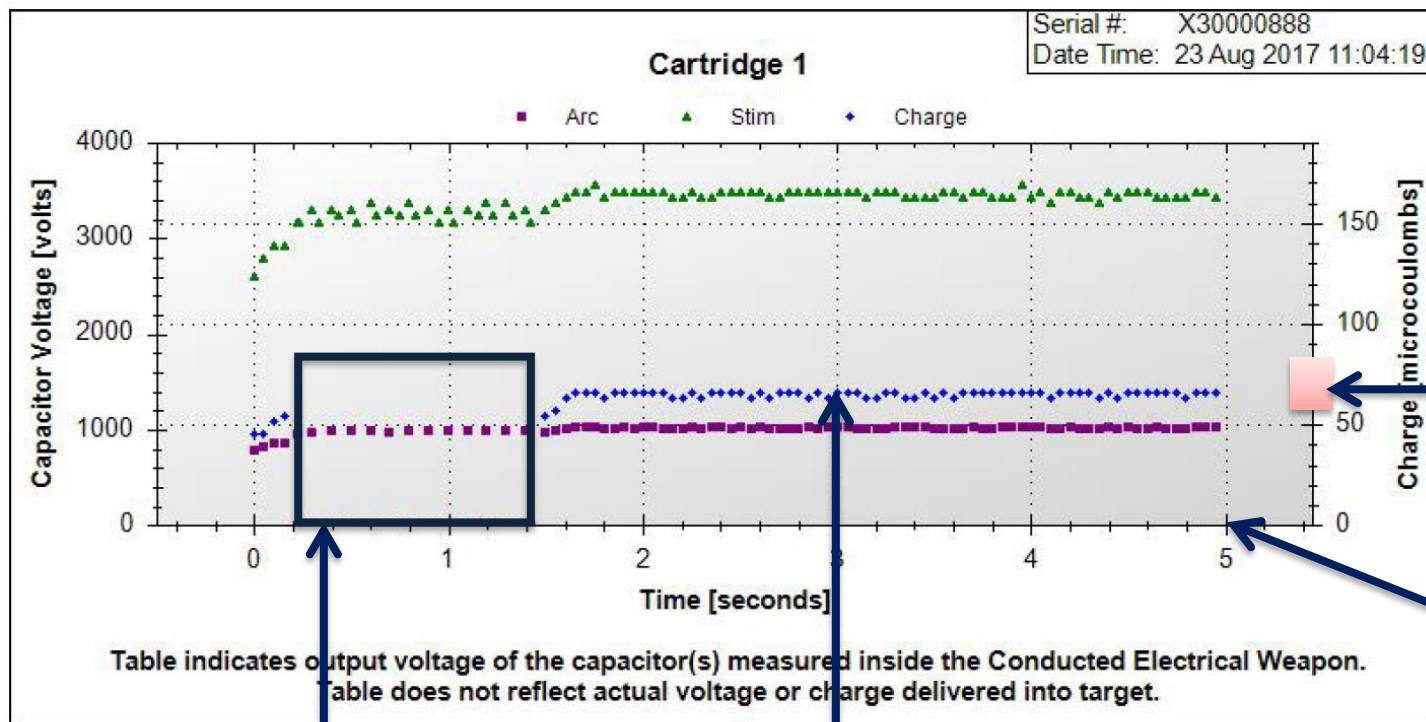

Charge is within CEW specified tolerance range

Graph indicates duration was 5 seconds

No charge and no discharge path from the weapon to a conductive target. PPS lowers

Consistent charge showing there is a discharge path from the weapon to a conductive target



Basic Drills

Live Fire Drills

Practical Exercises

Conclusion And Written Examinations





Axon, X2, X26, X26P, M26, TASER, Smart Cartridge, SPPM, and the “Bolt within Circle Logo” are trademarks of Axon Enterprise, Inc., some of which are registered in the US and other countries. For more information, visit www.axon.com/legal. All rights reserved. © 2018 Axon Enterprise, Inc.

Dust-Off is a trademark of Falcon Safety Products, Inc.; PowerPoint is a trademark of Microsoft Corporation, and Sani-Cloth is a trademark of Professional Disposables, Inc.